

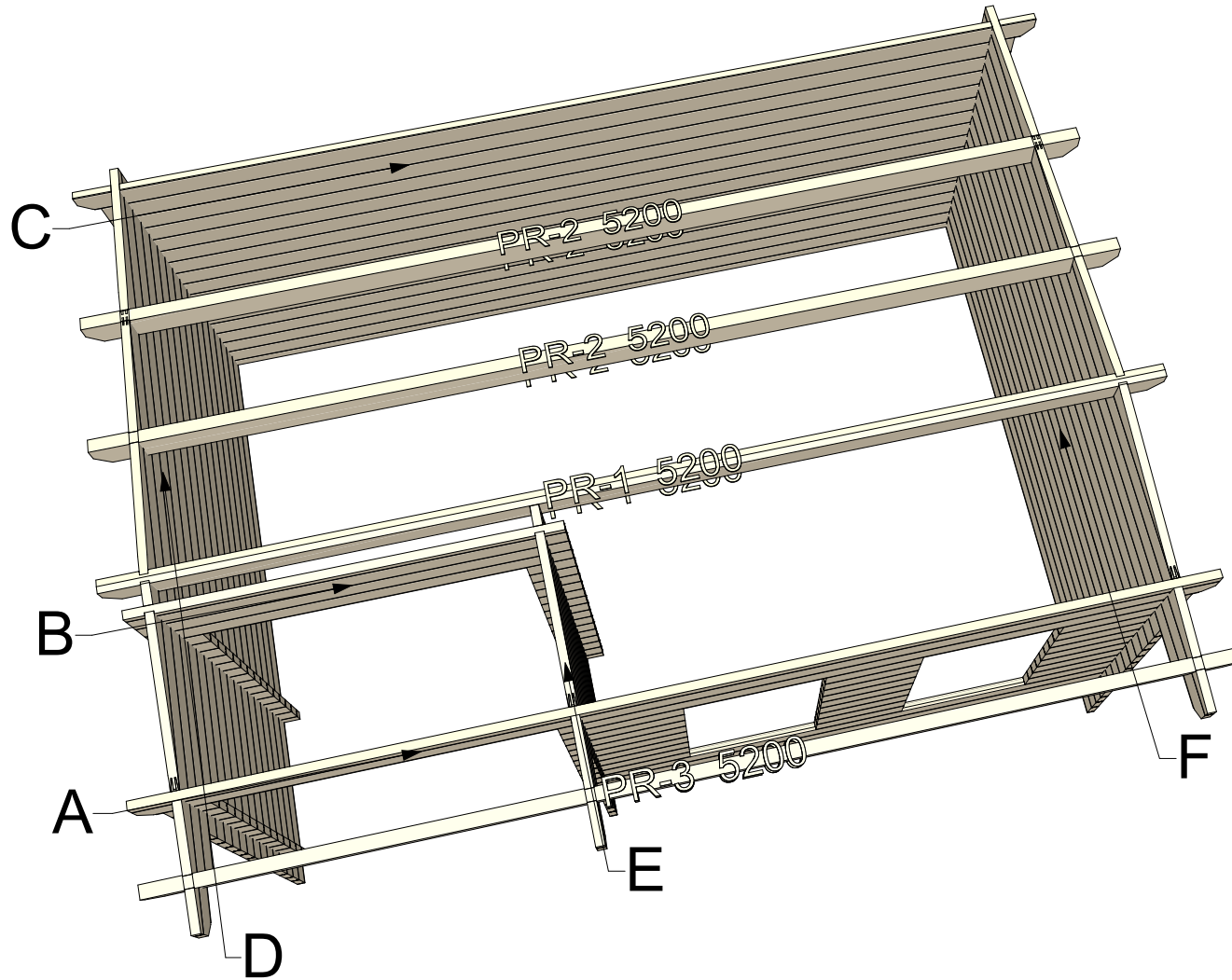

44 Shrewsbury 5x3,5

Walls and purlins positions



Thickness:	Project name:	Project ID:	Year:	Page:
44	Shrewsbury 5x3,5		2023	2

Floor bearer

1:40

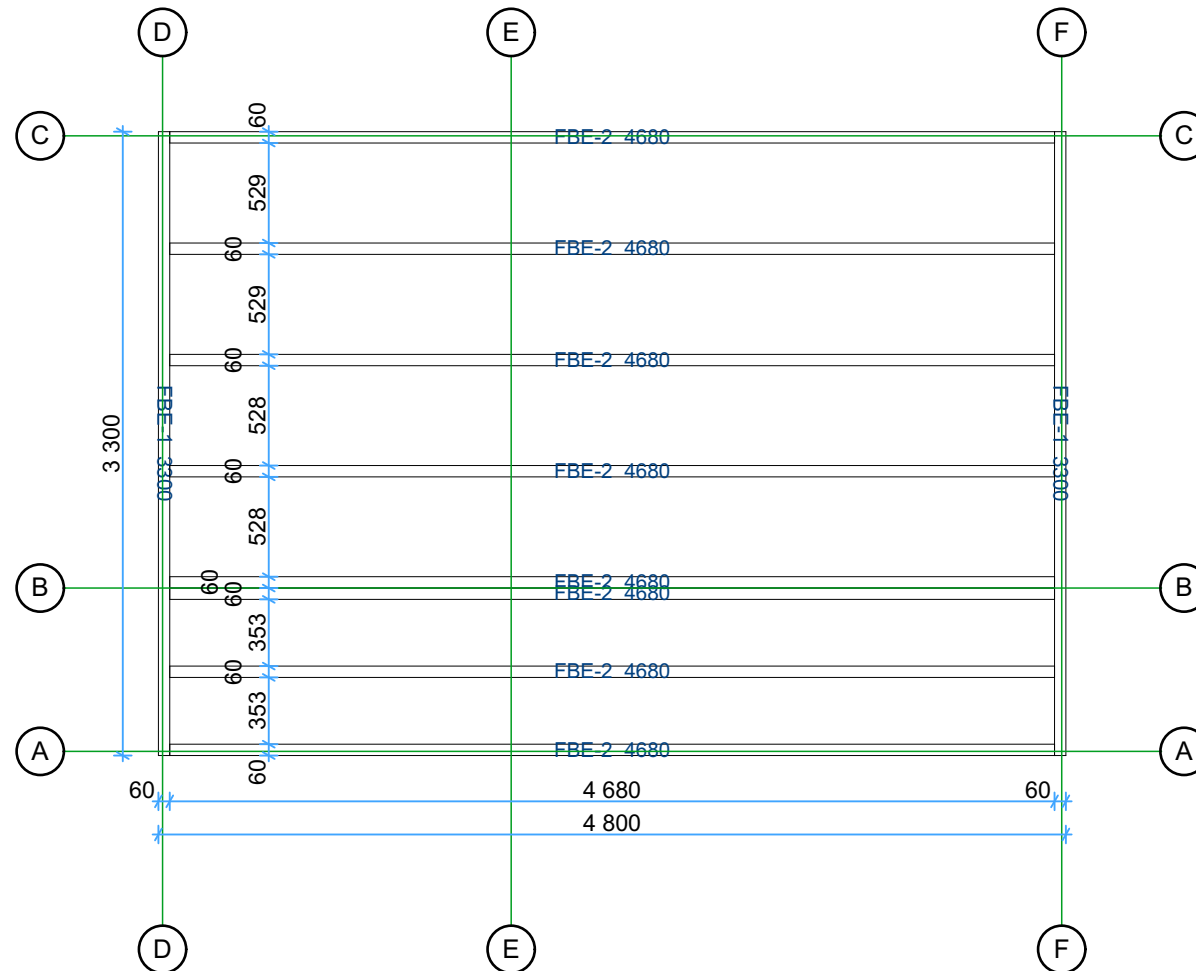

Thickness:	Project name:	Project ID:	Year:	Page:
44	Shrewsbury 5x3,5		2023	3

Floor boards

1:40

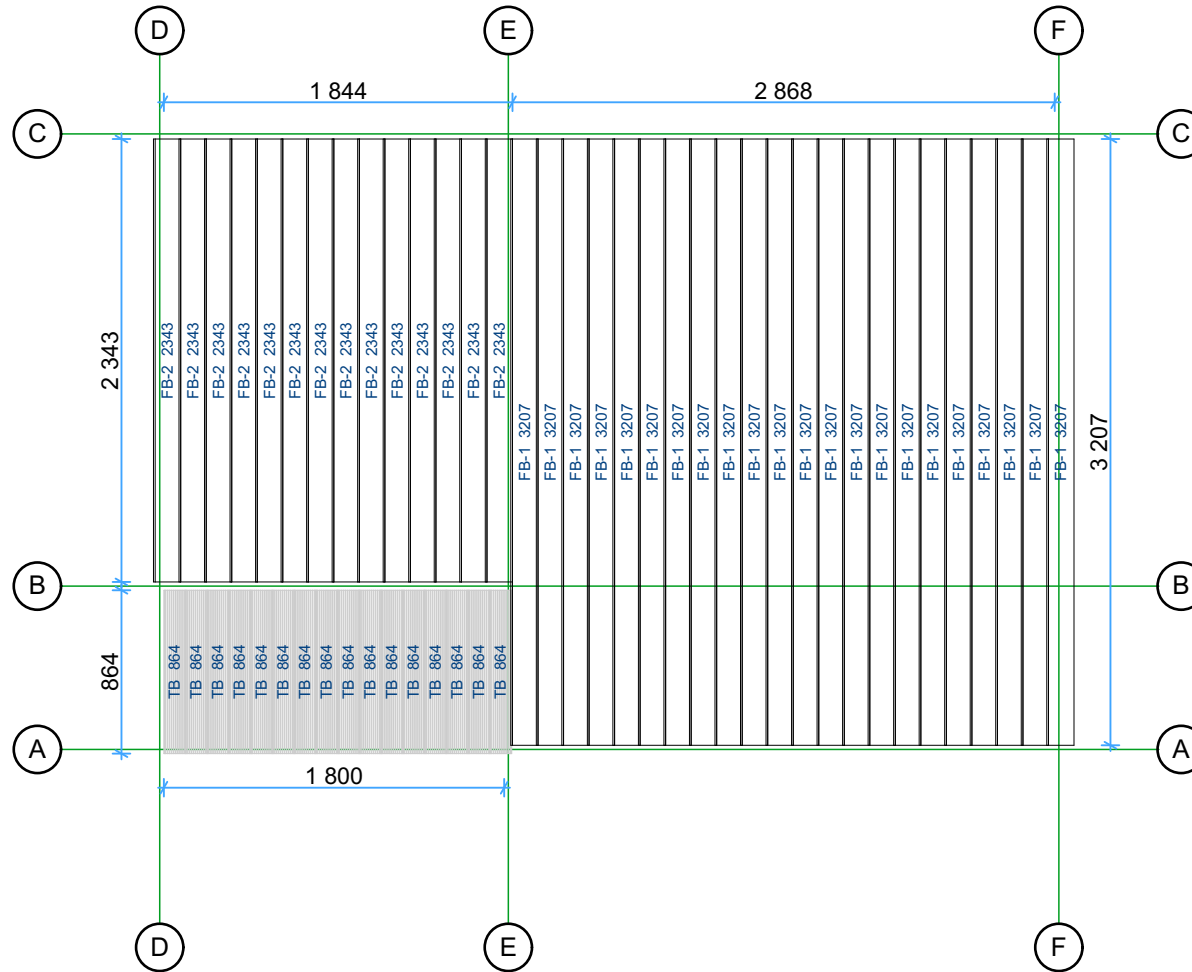

Thickness:	Project name:	Project ID:	Year:	Page:
44	Shrewsbury 5x3,5		2023	4

Ground Floor plan

1:40

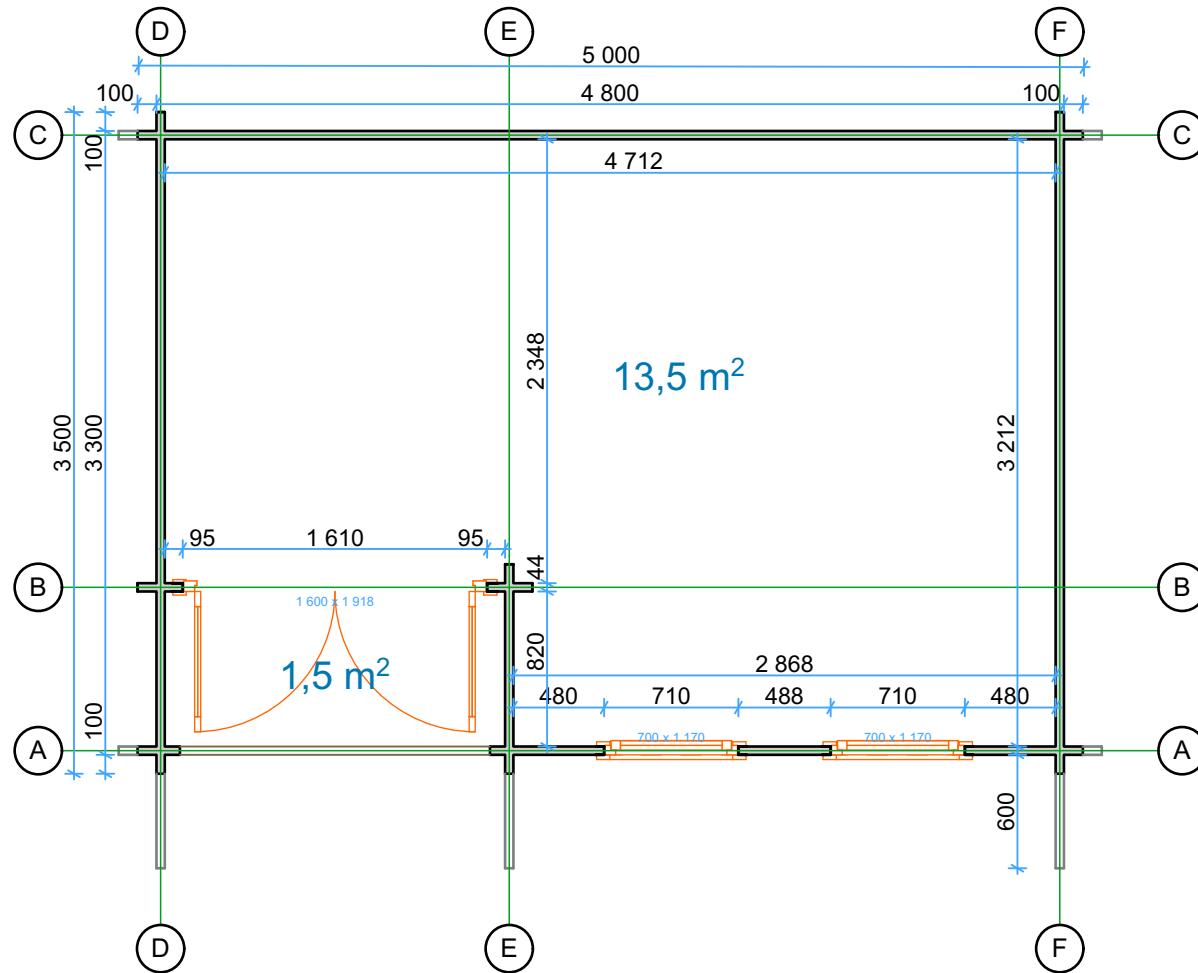

Thickness:	Project name:	Project ID:	Year:	Page:
44	Shrewsbury 5x3,5		2023	5

Roof boards

1:40

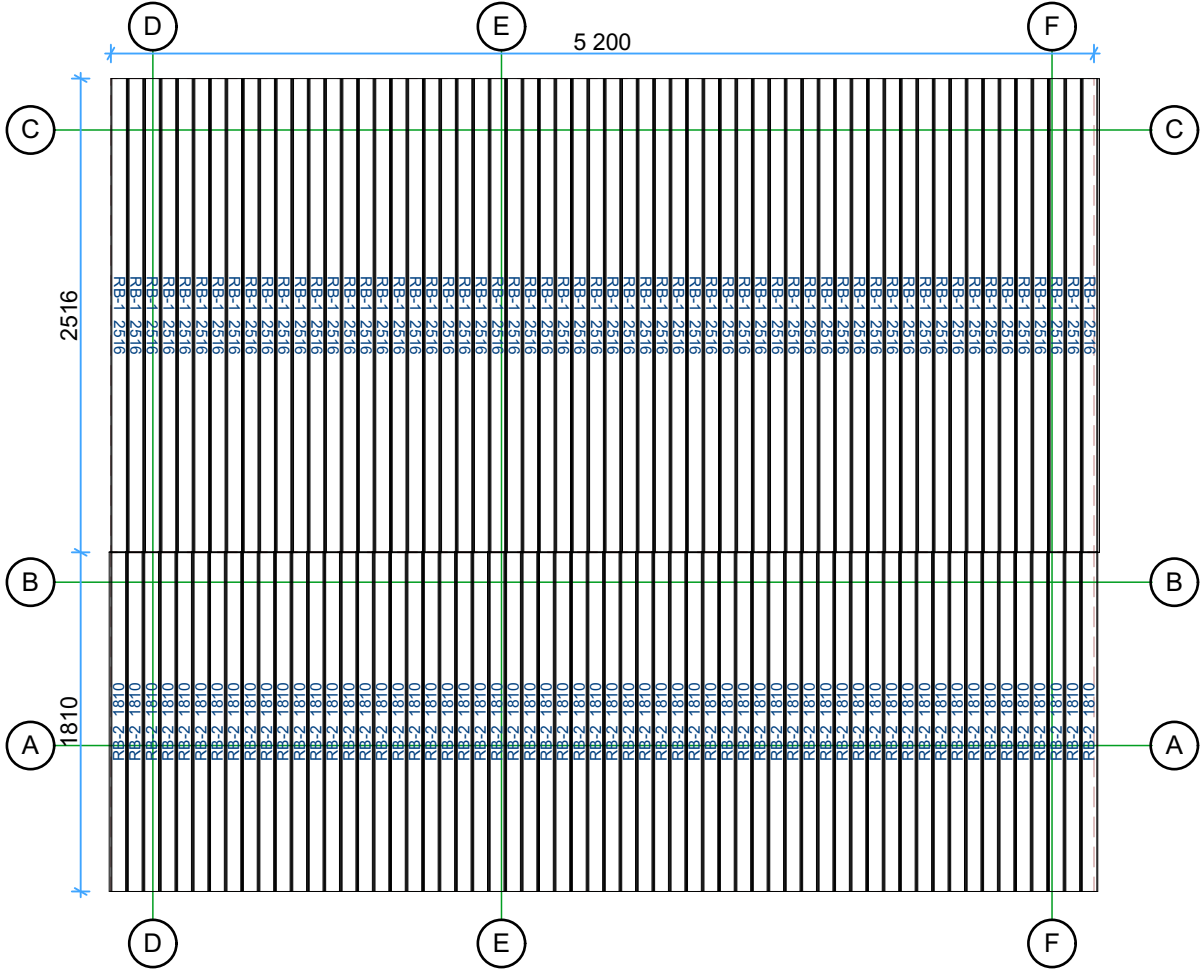

Thickness:	Project name:	Project ID:	Year:	Page:
44	Shrewsbury 5x3,5		2023	6

Wall A

1:40

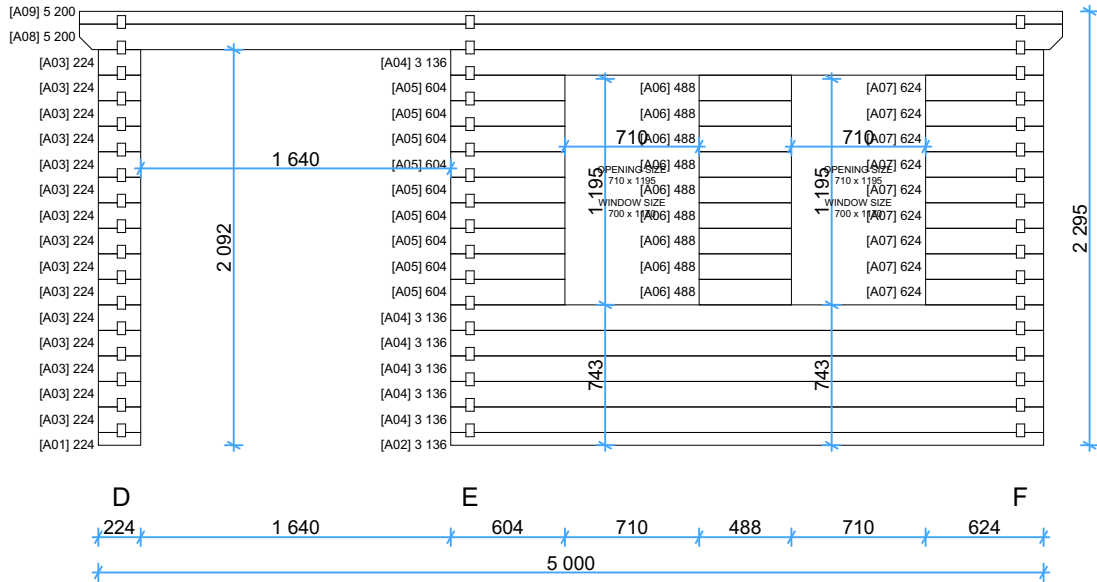

Wall B

1:40

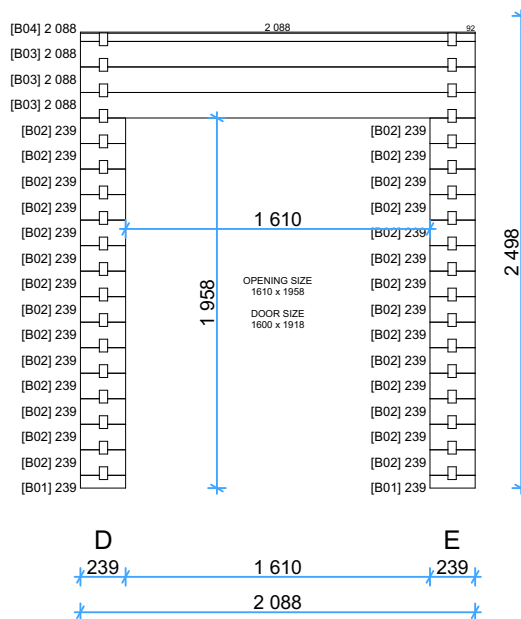

Wall C

1:40

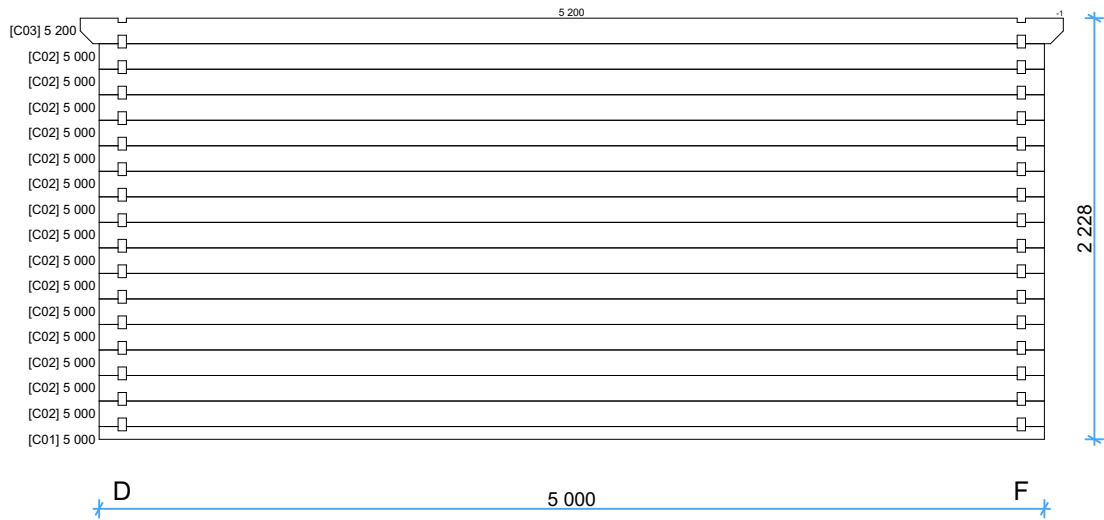

Wall D

1:40

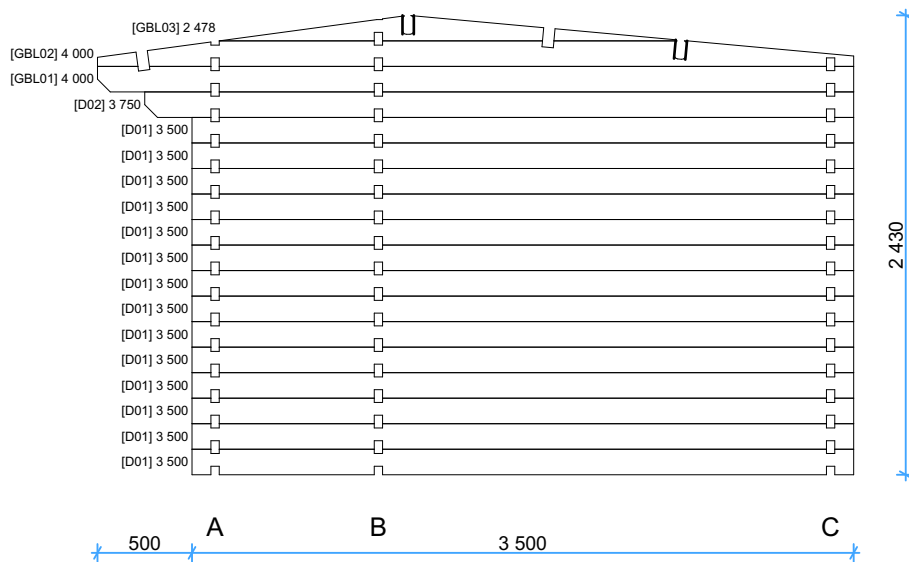

Thickness:	Project name:	Project ID:	Year:	Page:
44	Shrewsbury 5x3,5		2023	8

Wall E

1:40

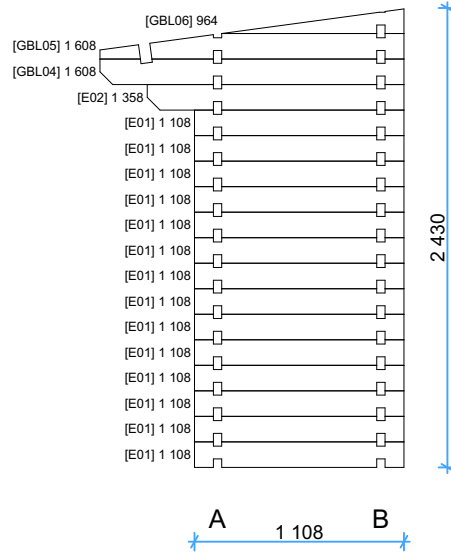

Wall F

1:40

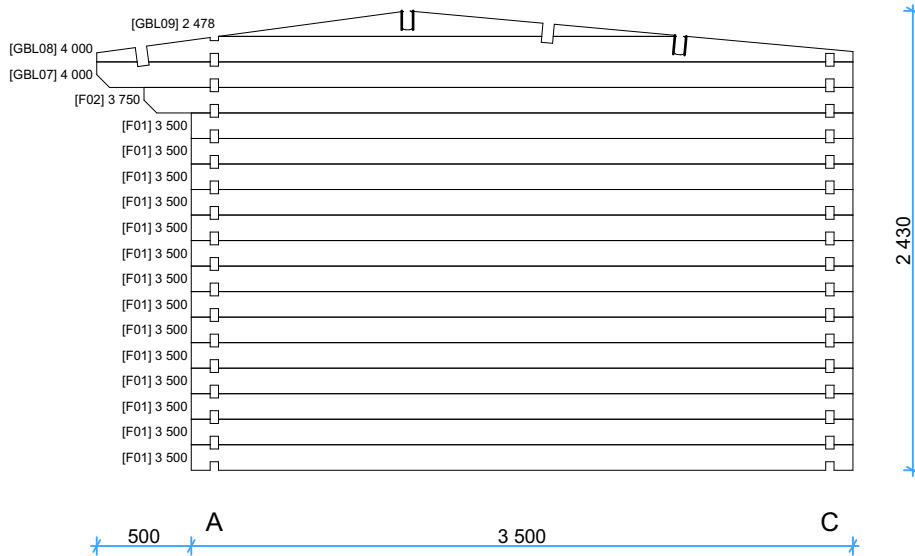

Thickness:	Project name:	Project ID:	Year:	Page:
44	Shrewsbury 5x3,5		2023	9

44mm Shrewsbury 5x3,5 Windows and doors list

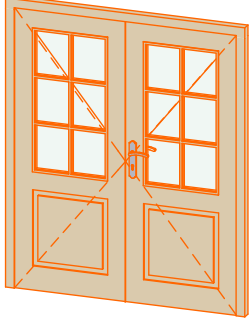
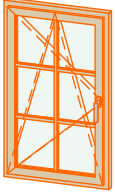
Type-quality	Barcode	Wall Thickness	W x H Size	Orientation	Glazing	Quantity	3D Axonometry
Door - Premium	PG192160-2	44	1 600×1 918	R	50% glass, double glazed, safety (toughened) glass	1	
Window - Premium plus	P+G11770	44	700×1 170	L	Double glazed, safety (toughened) glass	1	
Window - Premium plus	P+G11770	44	700×1 170	R	Double glazed, safety (toughened) glass	1	