

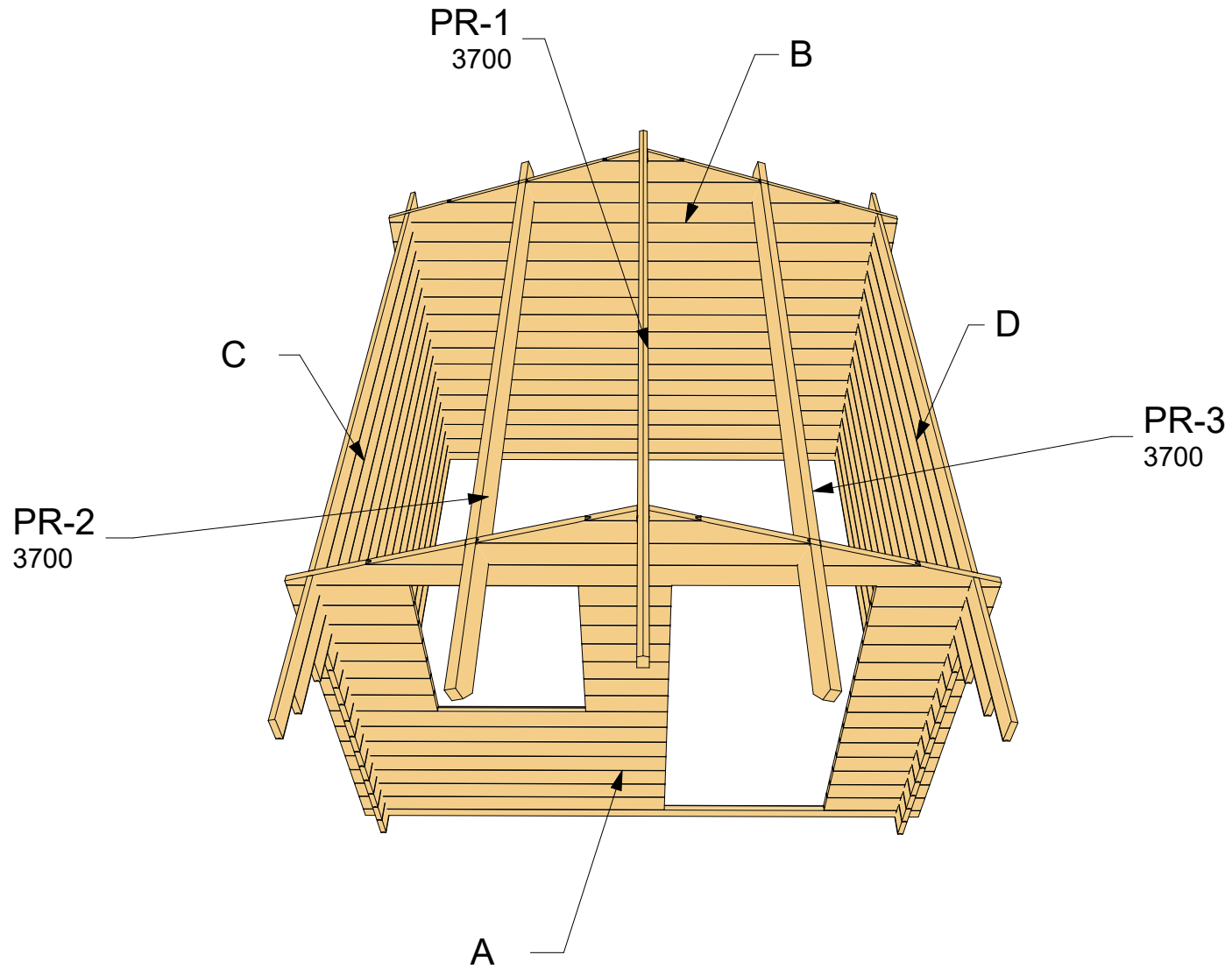

28mm Olympian bronze

Architect name:	Thickness:	Type:	Project name:	Project No:	Year:	Page:
Gytis Buda	28mm	Standard	Olympian bronze	-	2018	1 of 6

Walls and purlins positions



Architect name:	Thickness:	Type:	Project name:	Project No:	Year:	Page:
Gytis Buda	28mm	Standard	Olympian bronze	-	2018	2 of 6

Floor plan

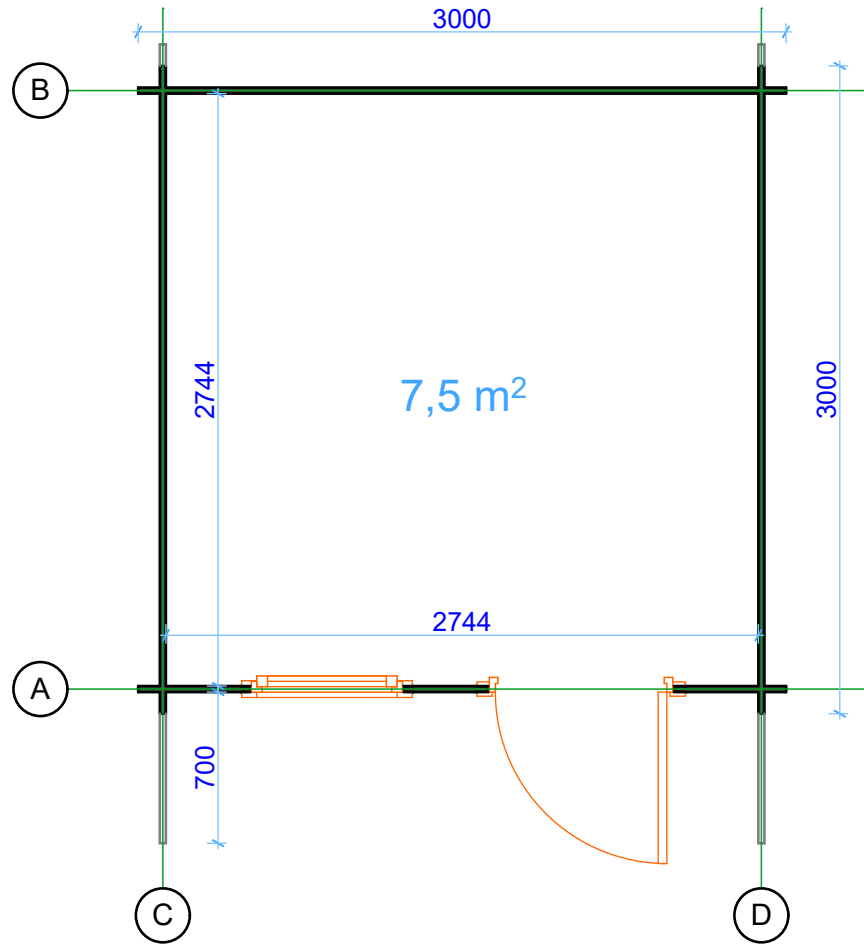

Floor bearers

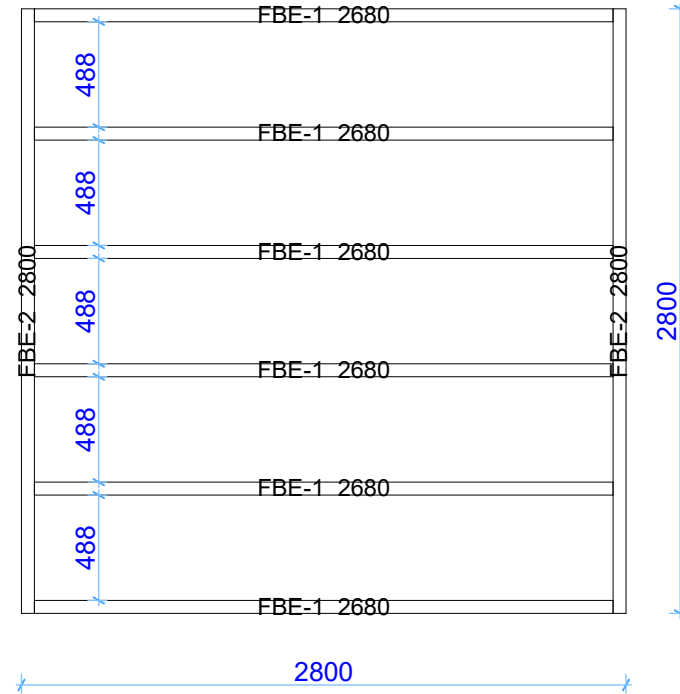

Architect name:	Thickness:	Type:	Project name:	Project No:	Year:	Page:
Gytis Buda	28mm	Standard	Olympian bronze	-	2018	3 of 6

Wall A

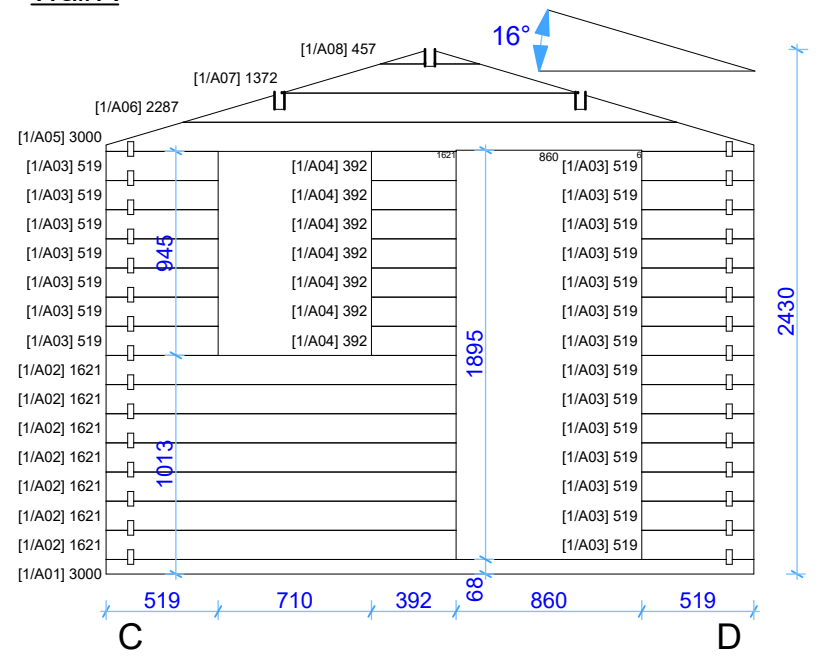

Wall C

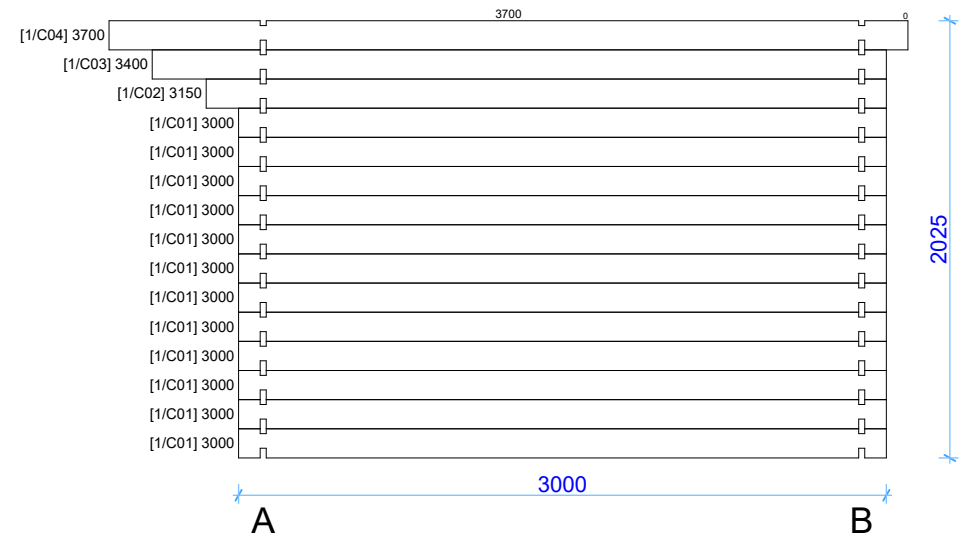

Wall B

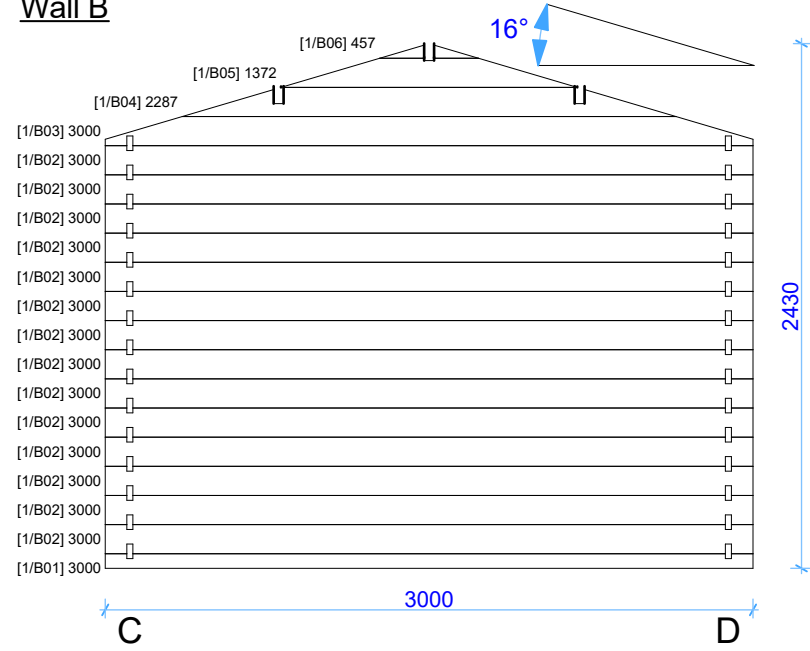

Wall D

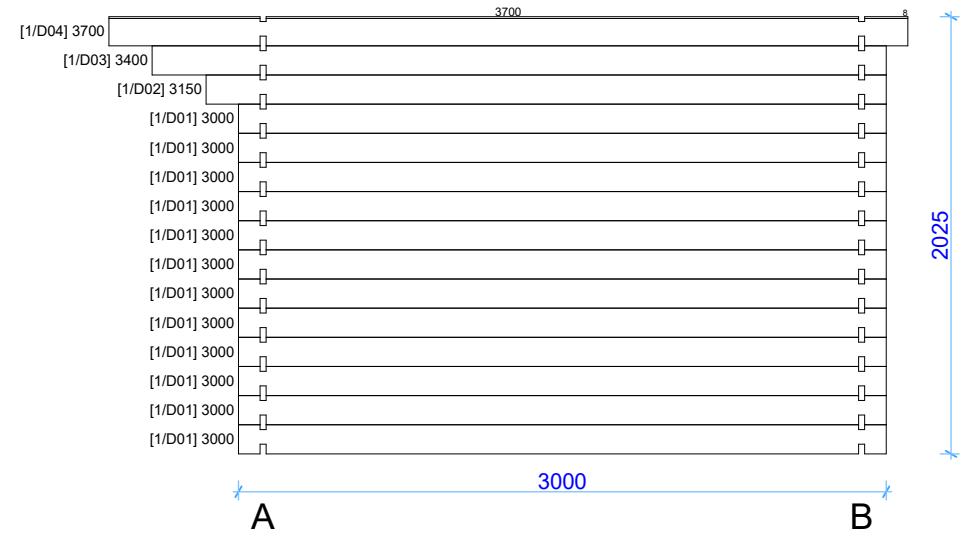

Architect name:	Thickness:	Type:	Project name:	Project No:	Year:	Page:
Gytis Buda	28mm	Standard	Olympian bronze	-	2018	4 of 6

Roof boards

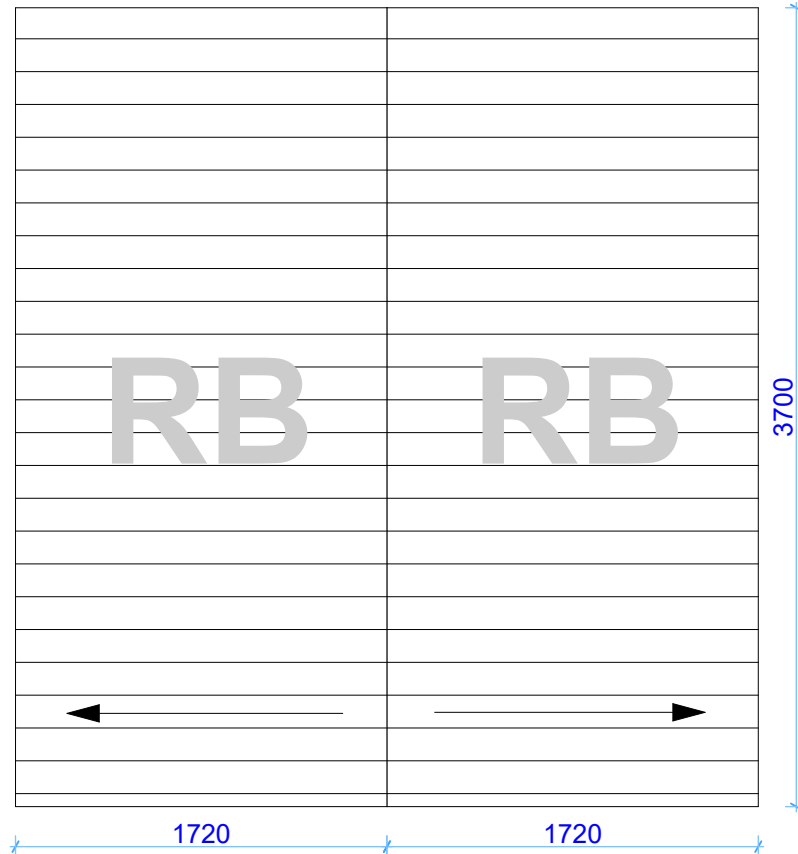

Floor boards

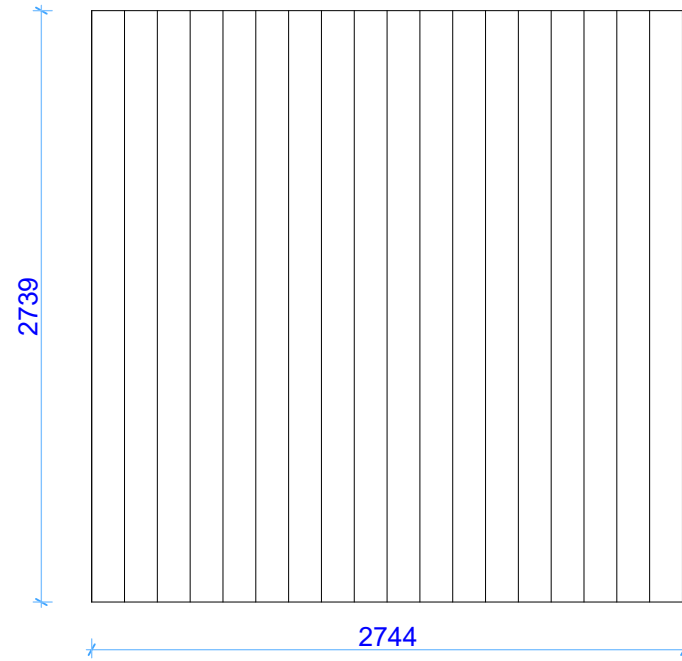

Architect name:	Thickness:	Type:	Project name:	Project No:	Year:	Page:
Gytis Buda	28mm	Standard	Olympian bronze	-	2018	5 of 6

Drip cap over window/door

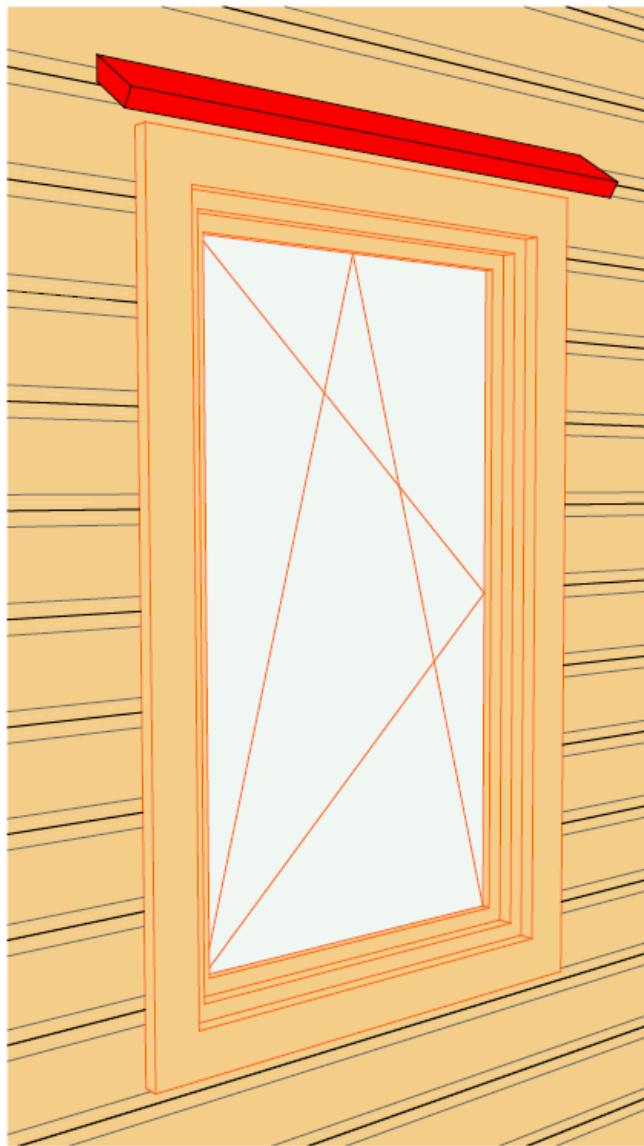

Drip cap over window/door

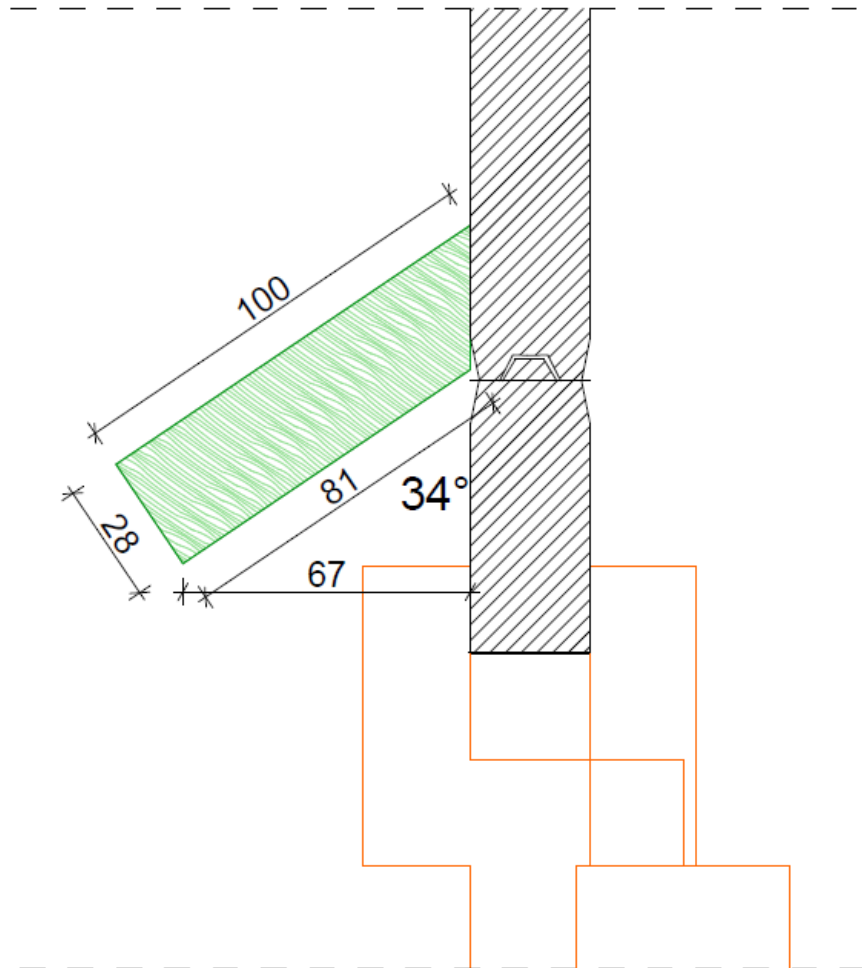

Architect name:	Thickness:	Type:	Project name:	Project No:	Year:	Page:
Gytis Buda	28mm	Standard	Olympian bronze	-	2018	6 of 6