

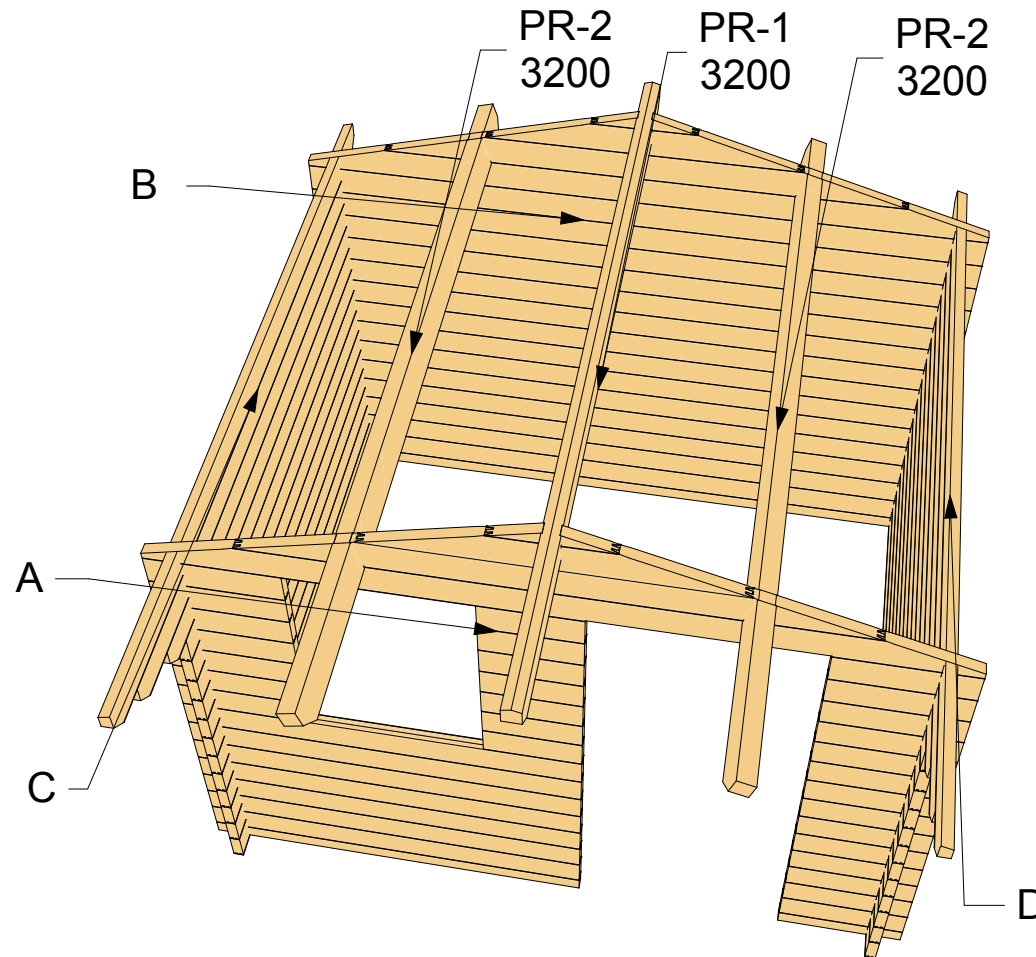

44mm Eastbourne 3x2,5

Architect name:	Thickness:	Type:	Project name:	Project No:	Year:	Page:
Laura Daubaraitė	44mm	Standard	Eastbourne 3x2,5		2019	1

Walls and purlins positions



Architect name:	Thickness:	Type:	Project name:	Project No:	Year:	Page:
Laura Daubaraitė	44mm	Standard	Eastbourne 3x2,5		2019	2

Floor bearers

1:40

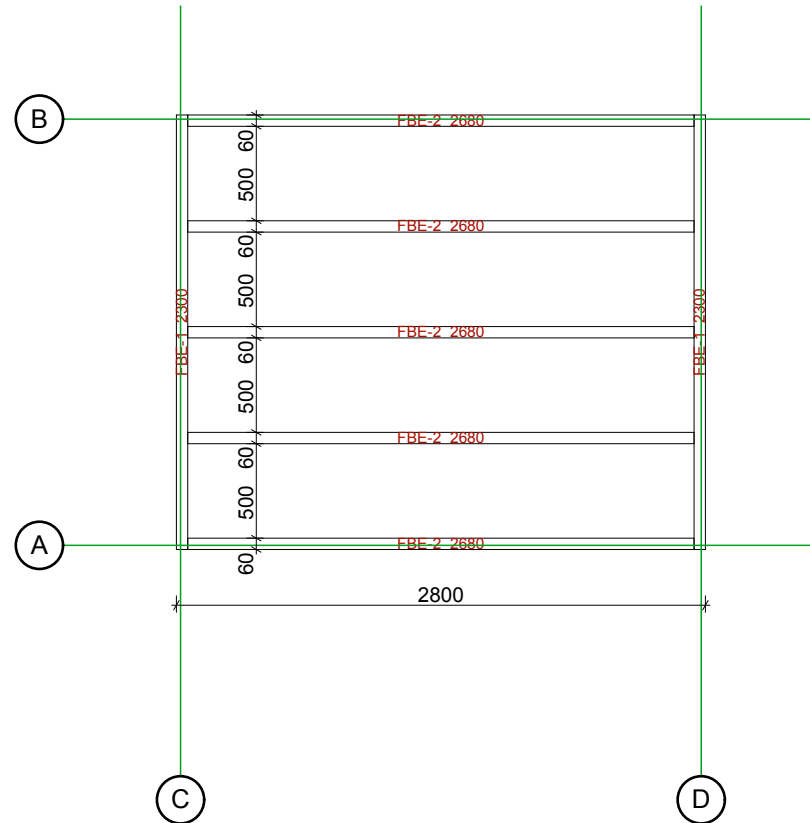

Floor boards

1:40

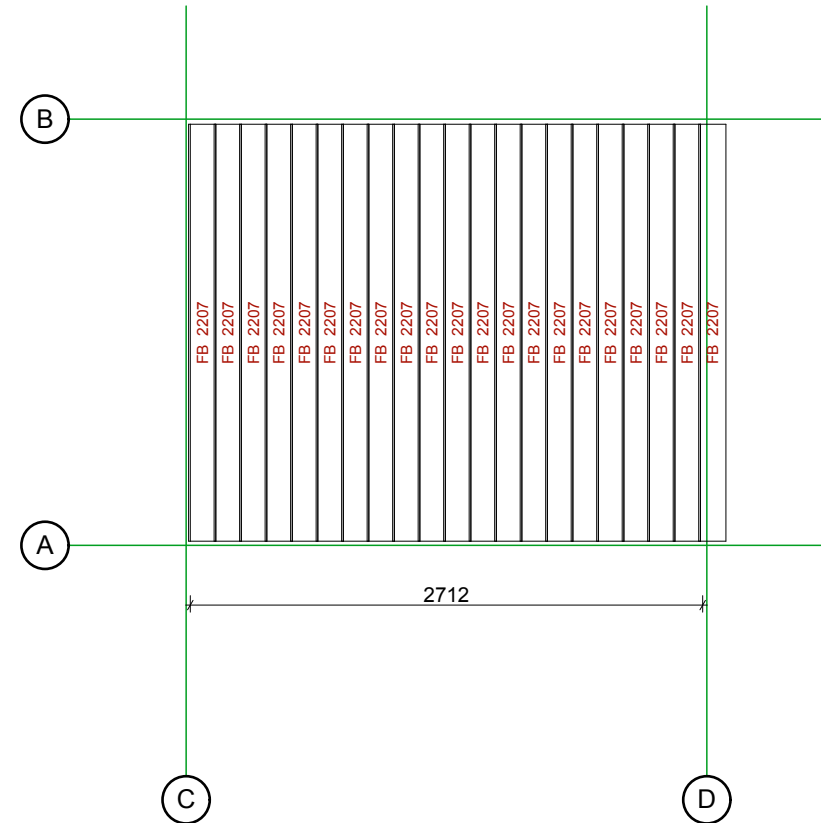

Architect name:	Thickness:	Type:	Project name:	Project No:	Year:	Page:
Laura Daubaraitė	44mm	Standard	Eastbourne 3x2,5		2019	4

Wall A

1:40

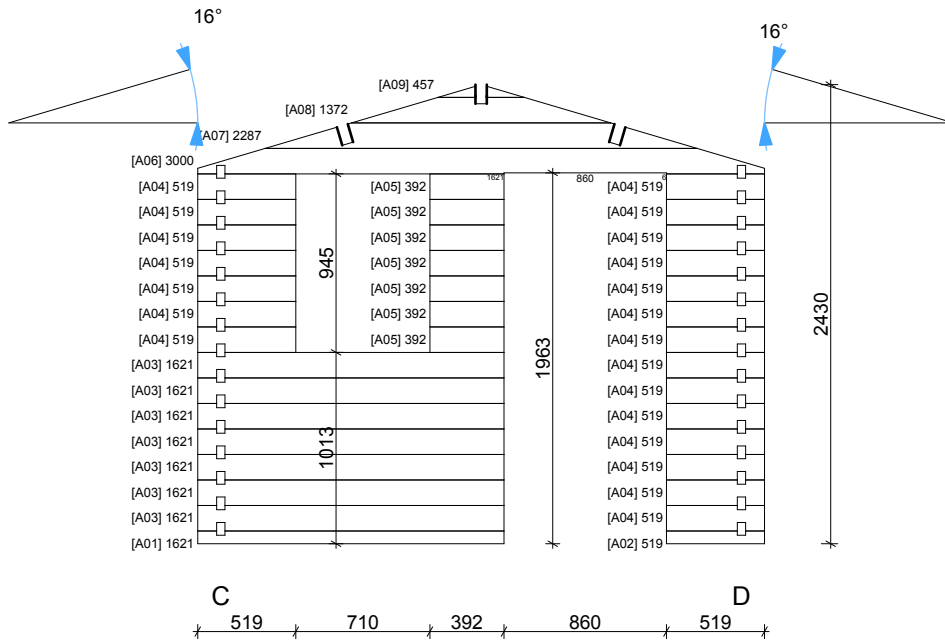

Wall B

1:40

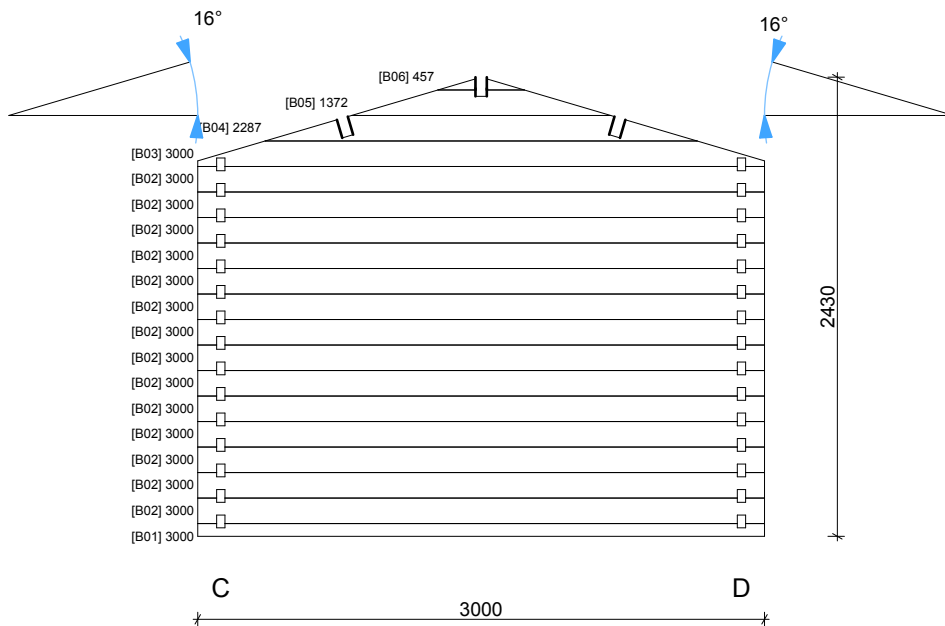

Architect name:	Thickness:	Type:	Project name:	Project No:	Year:	Page:
Laura Daubaraitė	44mm	Standard	Eastbourne 3x2,5	#PIIn	2019	5

Wall C

1:40

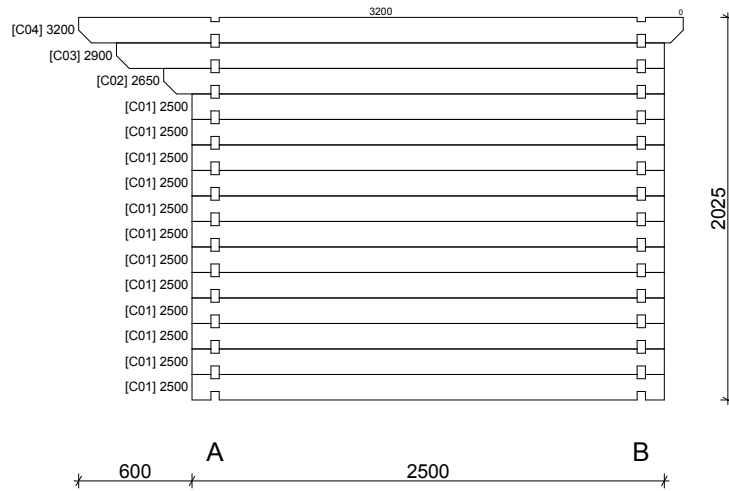

Wall D

1:40

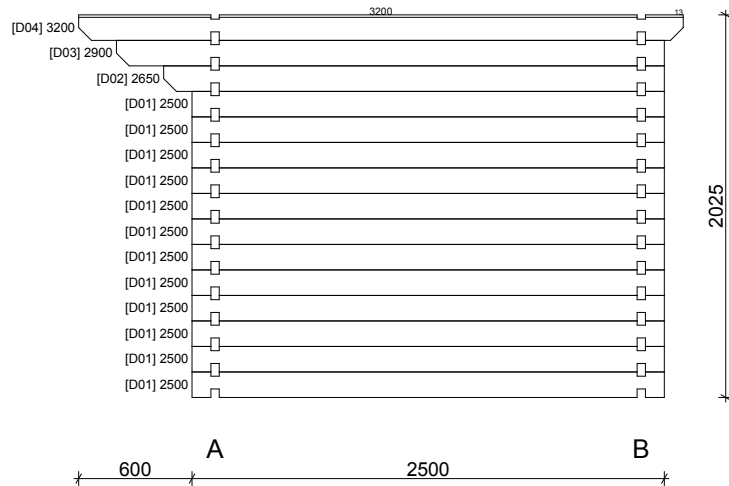

Architect name:	Thickness:	Type:	Project name:	Project No:	Year:	Page:
Laura Daubaraitė	44mm	Standard	Eastbourne 3x2,5	#PIn	2019	6