

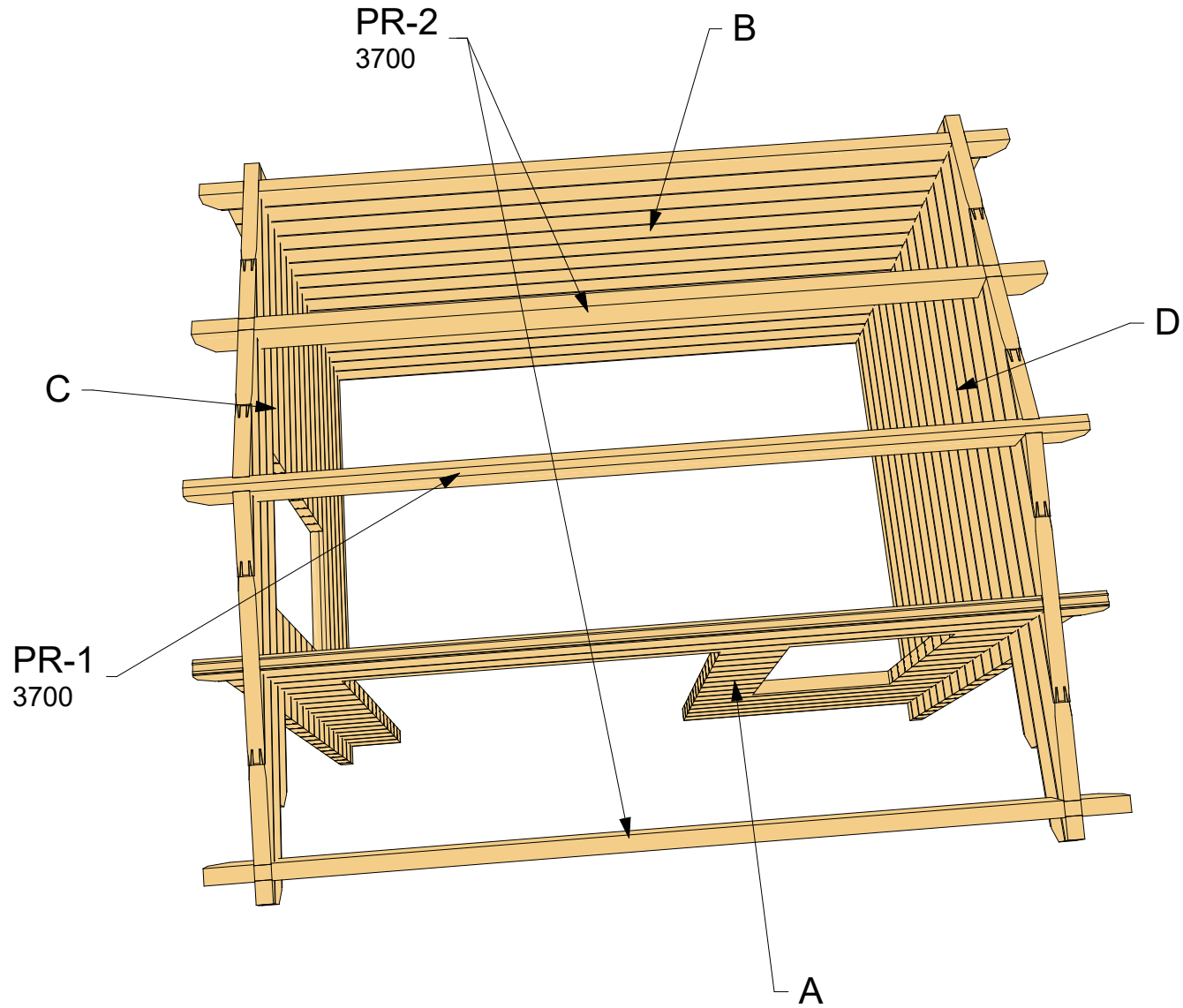

## 68mm Colchester 3,5x2,5

| Architect name: | Thickness: | Type:    | Project name:             | Project No: | Year: | Page:  |
|-----------------|------------|----------|---------------------------|-------------|-------|--------|
| Gytis Buda      | 68mm       | Standard | <b>COLCHESTER 3,5x2,5</b> | -           | 2018  | 1 of 5 |

Walls and purlins positions



| Architect name: | Thickness: | Type:    | Project name:             | Project No: | Year: | Page:  |
|-----------------|------------|----------|---------------------------|-------------|-------|--------|
| Gytis Buda      | 68mm       | Standard | <b>COLCHESTER 3,5x2,5</b> | -           | 2018  | 2 of 5 |

Floor plan 1:40

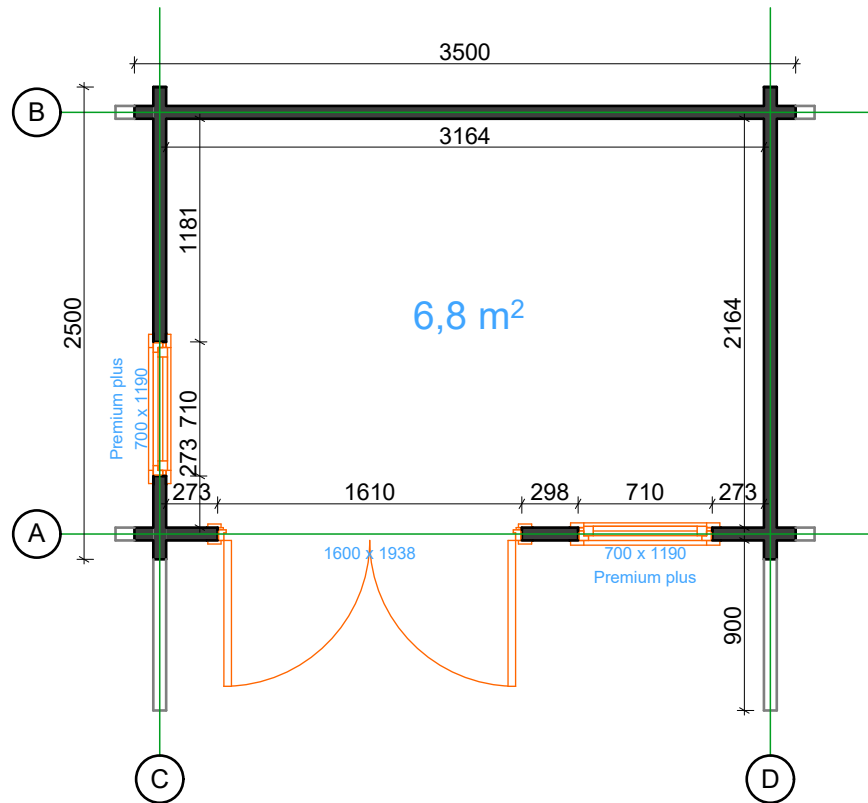

Floor bearers 1:40

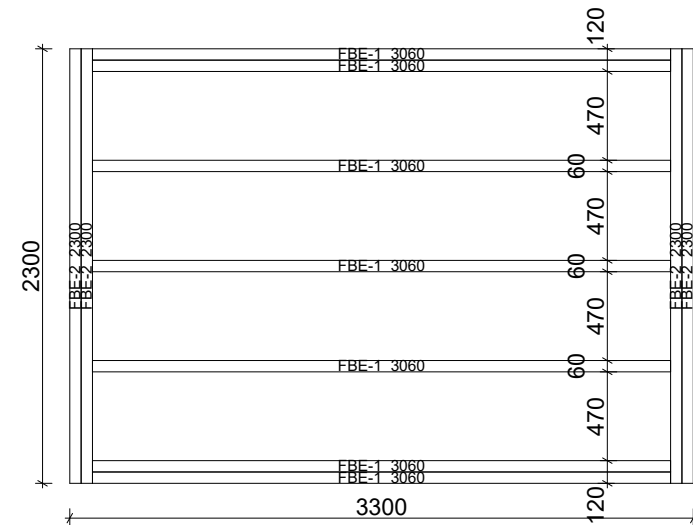

| Architect name:   | Thickness:  | Type:           | Project name:             | Project No: | Year:       | Page:         |
|-------------------|-------------|-----------------|---------------------------|-------------|-------------|---------------|
| <b>Gytis Buda</b> | <b>68mm</b> | <b>Standard</b> | <b>COLCHESTER 3,5x2,5</b> | -           | <b>2018</b> | <b>3 of 5</b> |

## Wall A

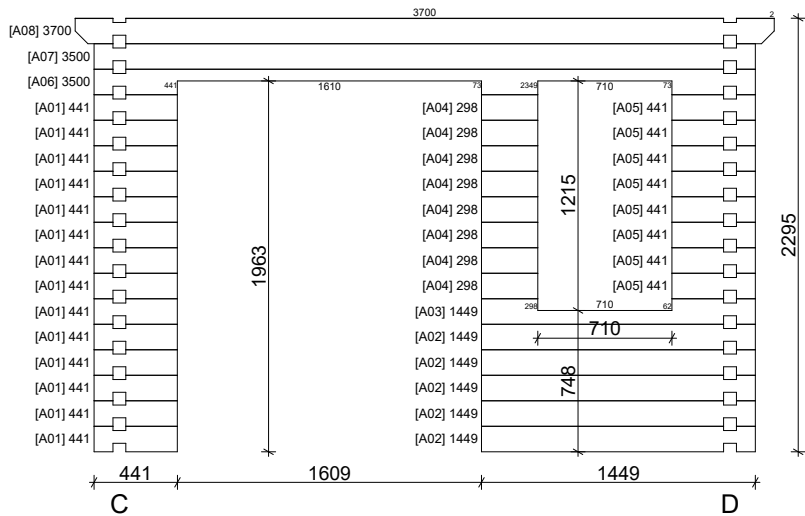

## Wall B

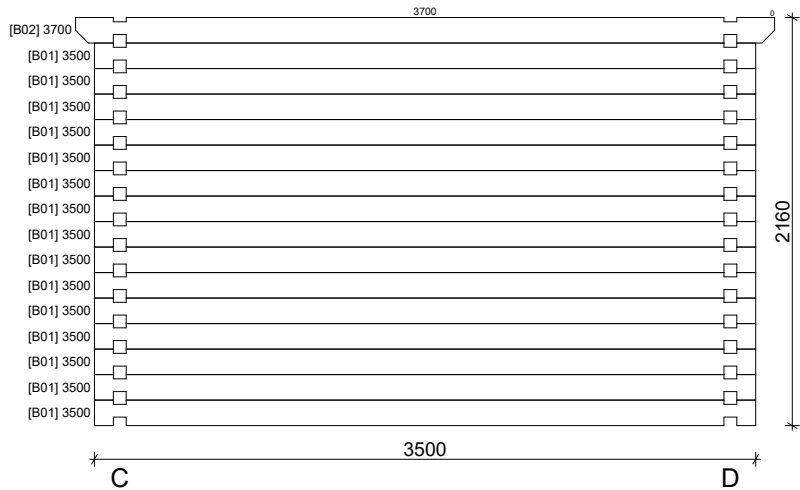

## Wall C

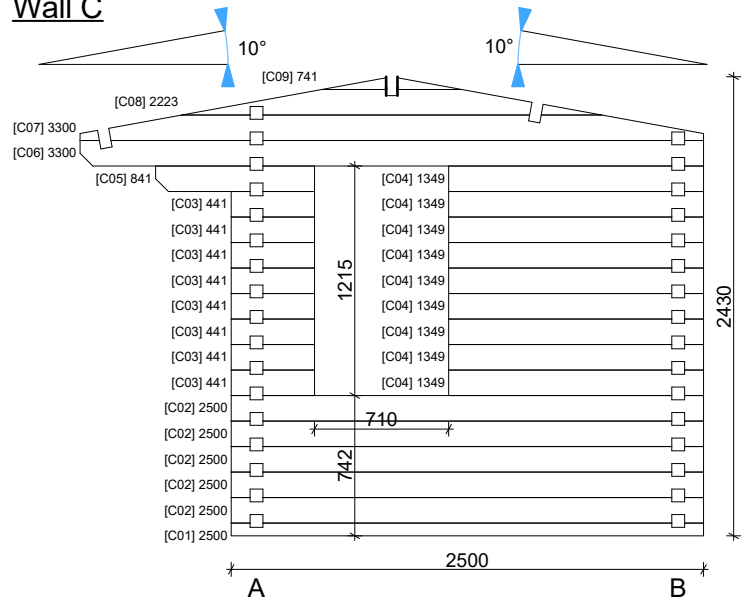

## Wall D

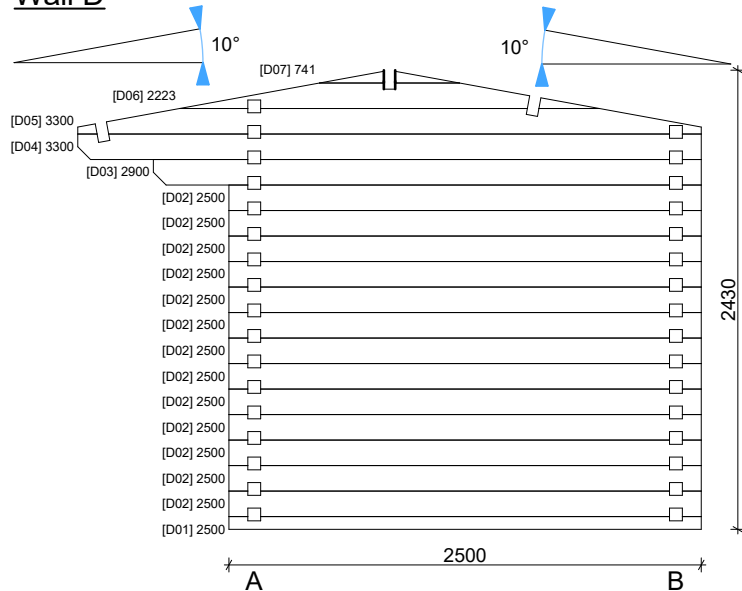

|                 |            |          |                    |             |       |        |
|-----------------|------------|----------|--------------------|-------------|-------|--------|
| Architect name: | Thickness: | Type:    | Project name:      | Project No: | Year: | Page:  |
| Gytis Buda      | 68mm       | Standard | COLCHESTER 3,5x2,5 | -           | 2018  | 4 of 5 |

Floor boards

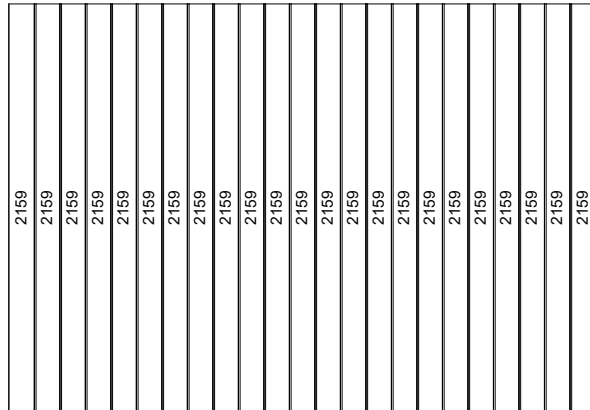

Roof boards

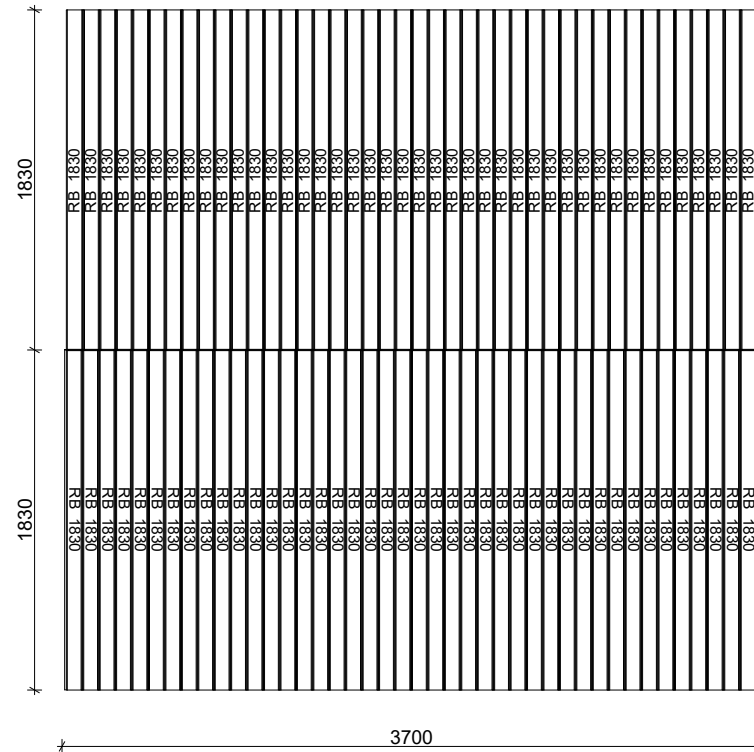

|                   |             |                 |                           |             |             |               |
|-------------------|-------------|-----------------|---------------------------|-------------|-------------|---------------|
| Architect name:   | Thickness:  | Type:           | Project name:             | Project No: | Year:       | Page:         |
| <b>Gytis Buda</b> | <b>68mm</b> | <b>Standard</b> | <b>COLCHESTER 3,5x2,5</b> | -           | <b>2018</b> | <b>5 of 5</b> |