

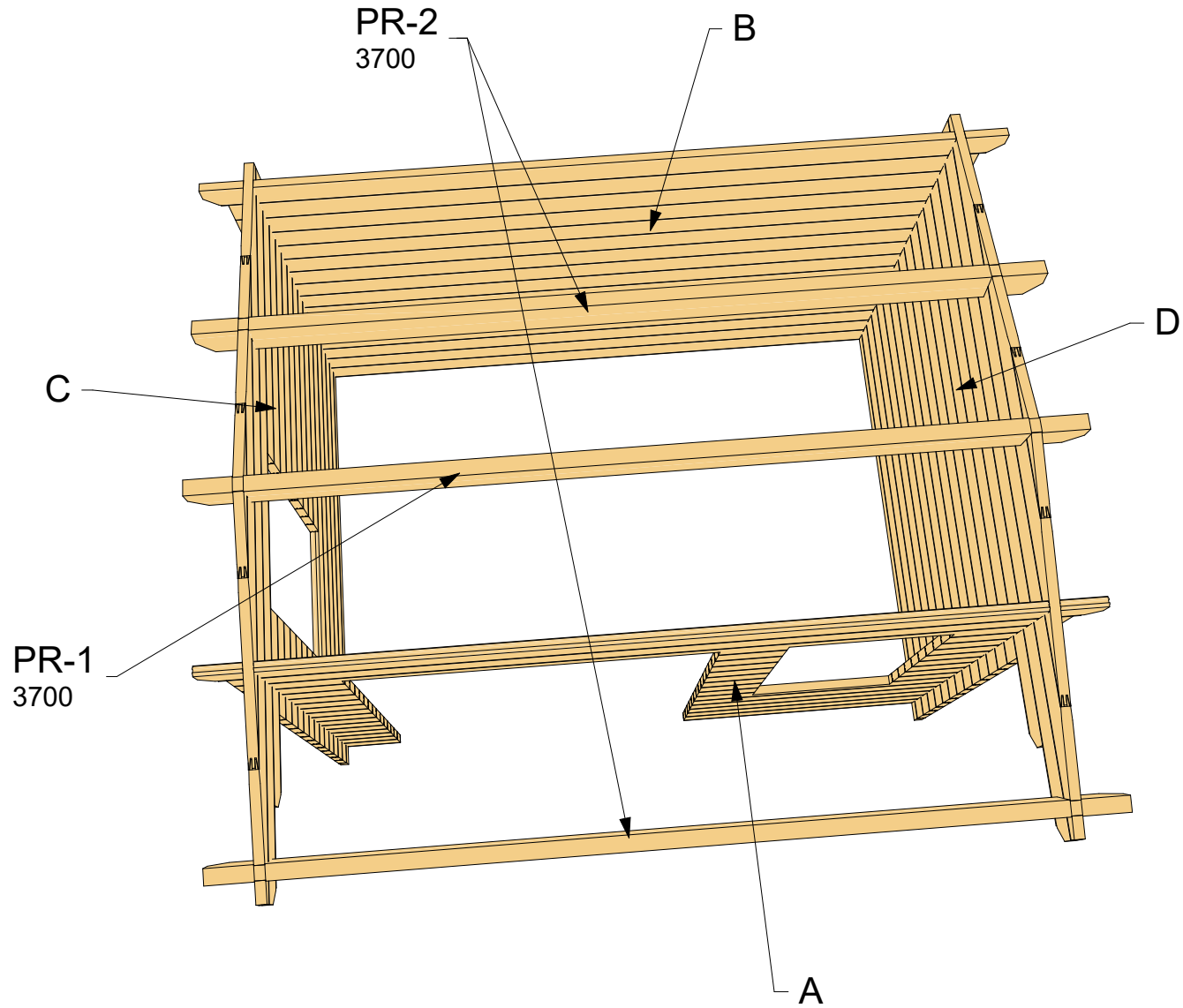

44mm Colchester 3,5x2,5

Architect name:	Thickness:	Type:	Project name:	Project No:	Year:	Page:
Gytis Buda	44mm	Standard	COLCHESTER 3,5x2,5	-	2018	1 of 5

Walls and purlins positions



Architect name:	Thickness:	Type:	Project name:	Project No:	Year:	Page:
Gytis Buda	44mm	Standard	COLCHESTER 3,5x2,5	-	2018	2 of 5

Floor plan 1:40

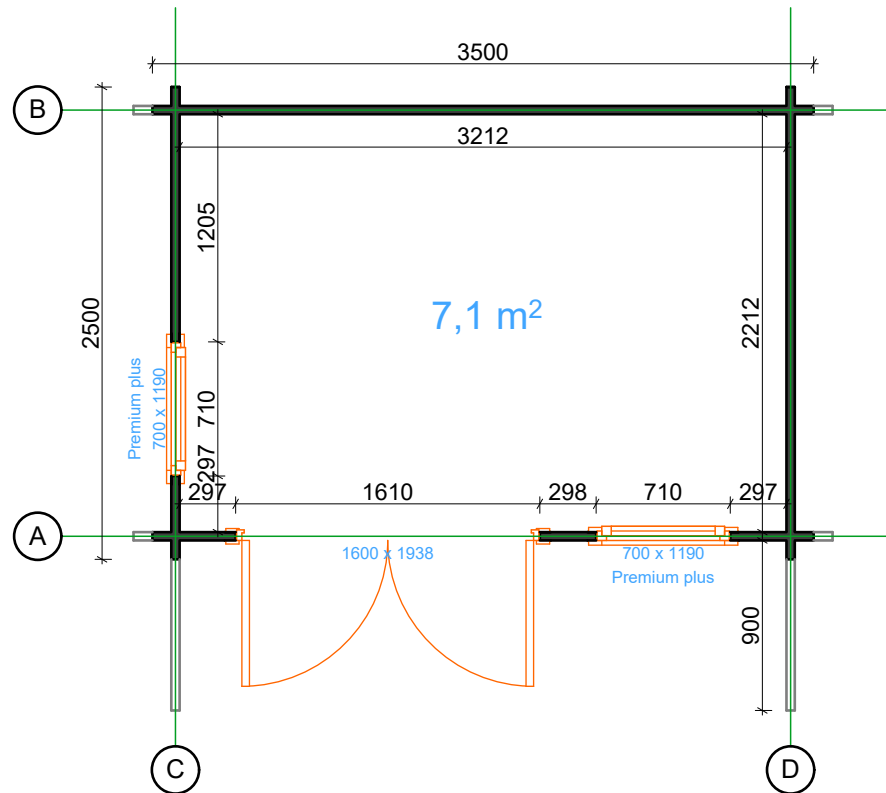

Floor bearers 1:40

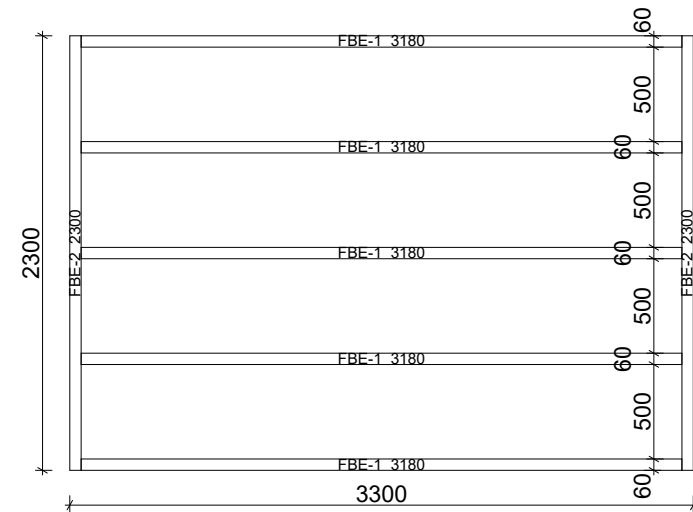

Architect name:	Thickness:	Type:	Project name:	Project No:	Year:	Page:
Gytis Buda	44mm	Standard	COLCHESTER 3,5x2,5	-	2018	3 of 5

Wall A

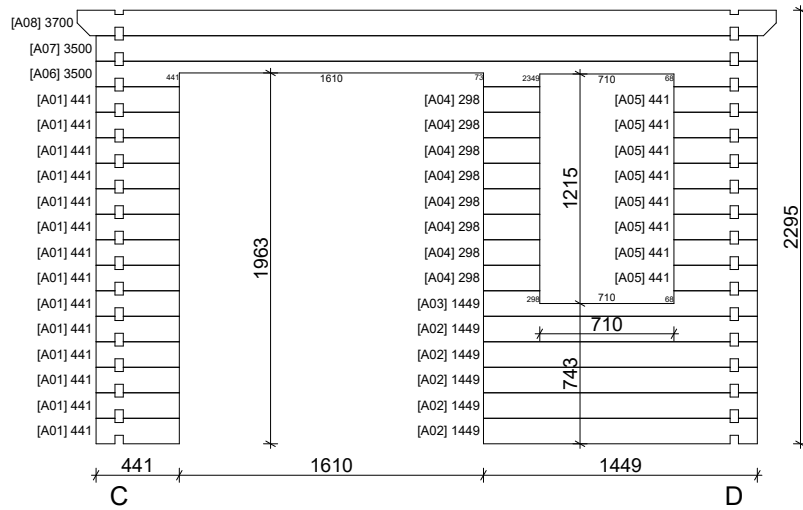

Wall C

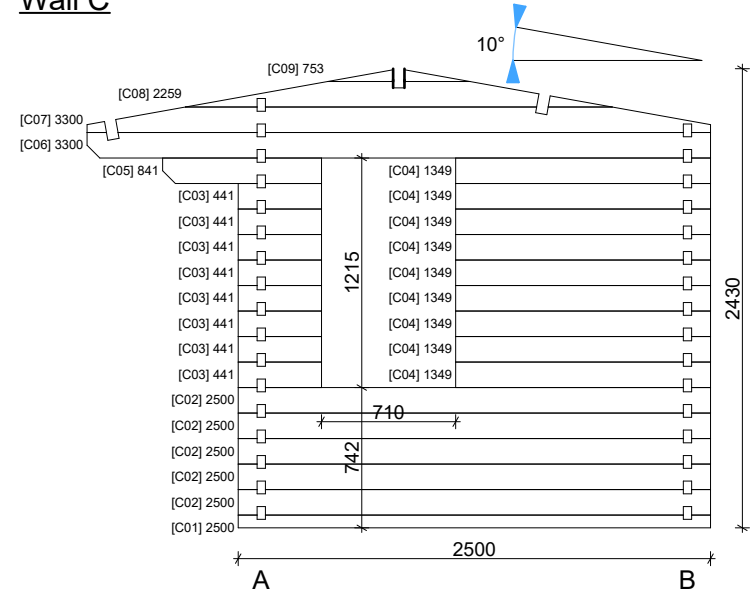

Wall B

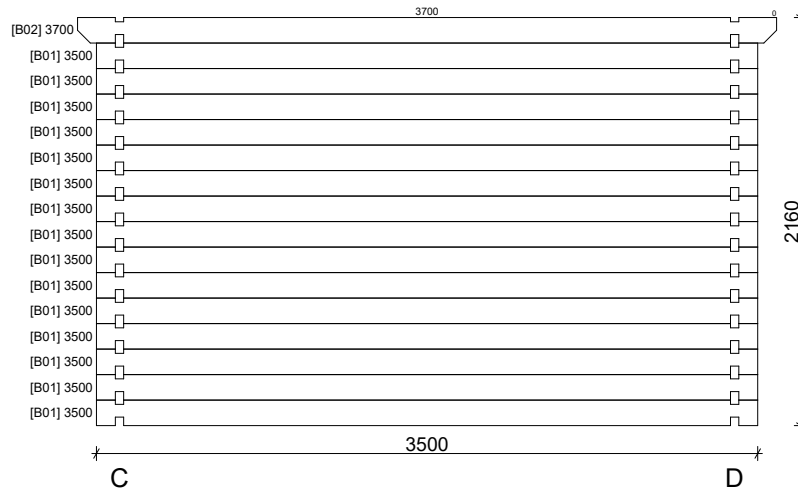

Wall D

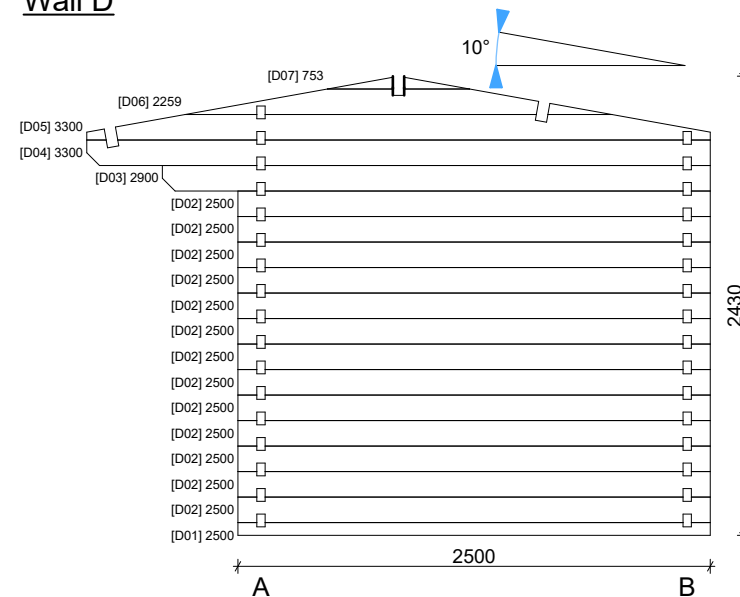

Architect name:	Thickness:	Type:	Project name:	Project No:	Year:	Page:
Gytis Buda	44mm	Standard	COLCHESTER 3,5x2,5	-	2018	4 of 5

