

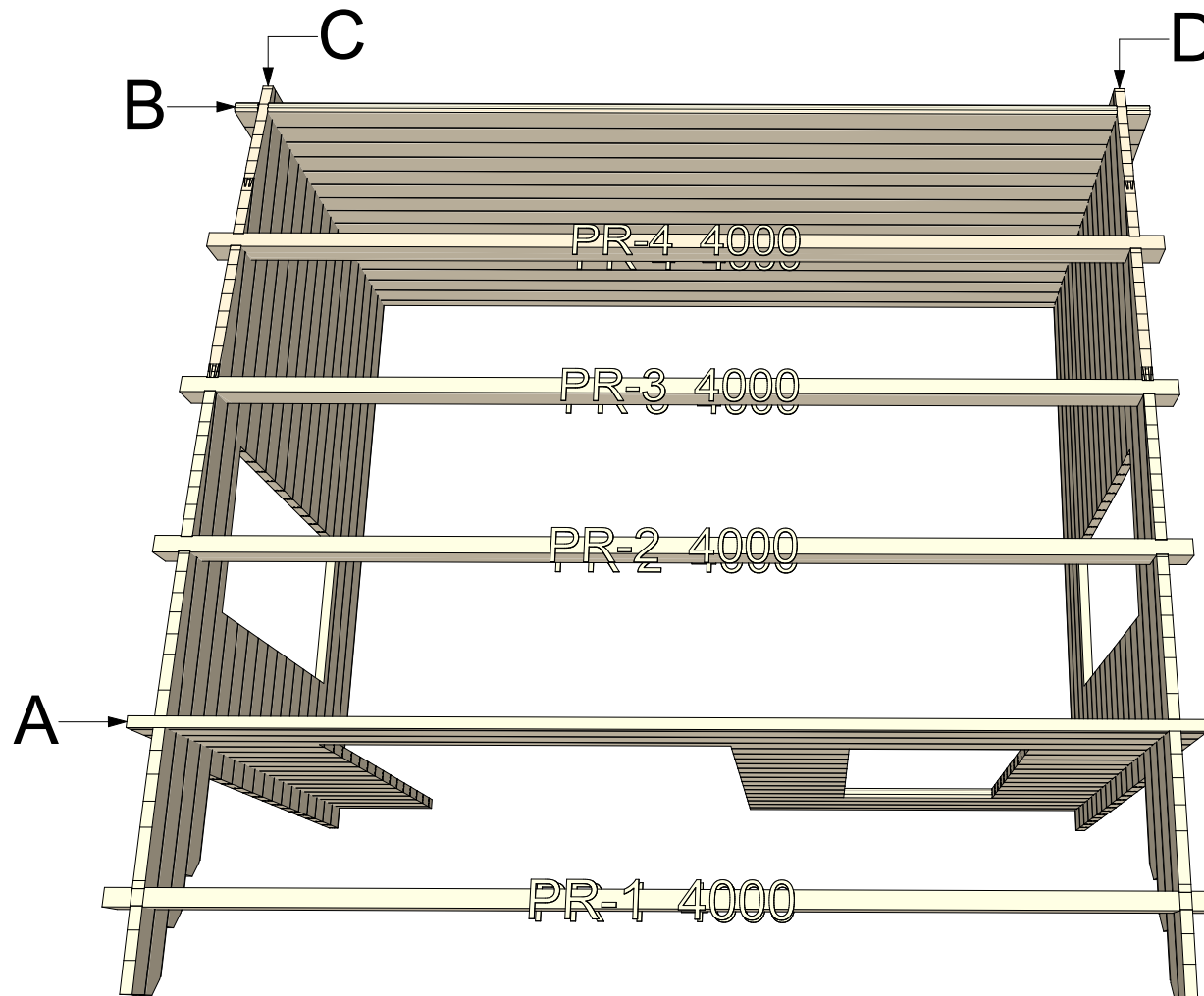

**44 Chertsey 4x3**

## Walls and purlins positions

1:150



Thickness:	Project name:	Project ID:	Year:	Page:
44	Chertsey	4x3	2021	2

Floor bearers 1:50

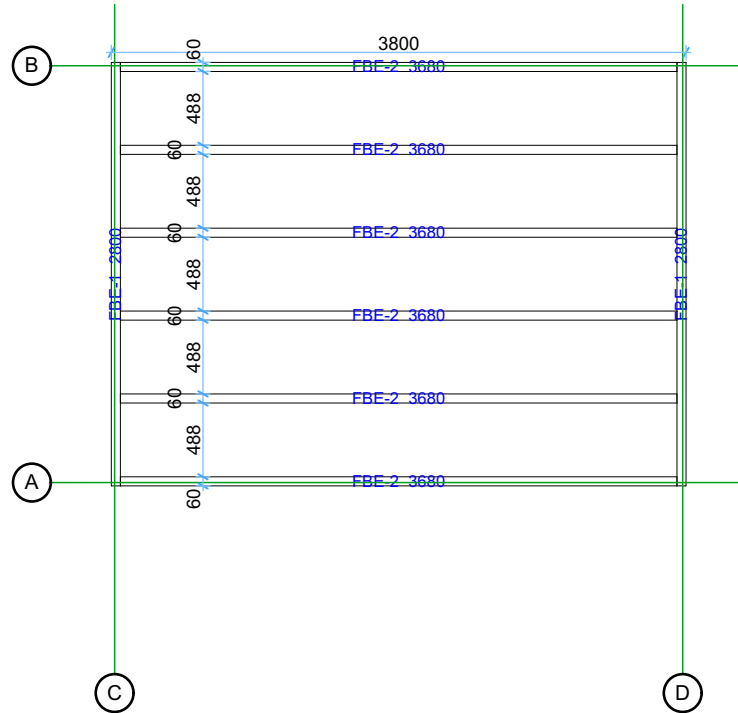

Floor boards 1:50

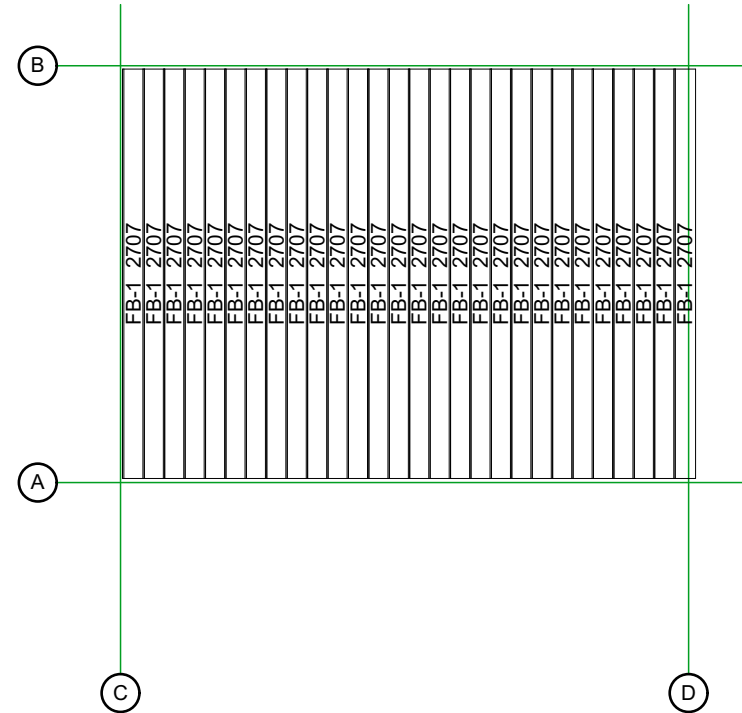

Thickness:	Project name:	Project ID:	Year:	Page:
44	Chertsey	4x3	2021	3

Ground floor plan 1:50

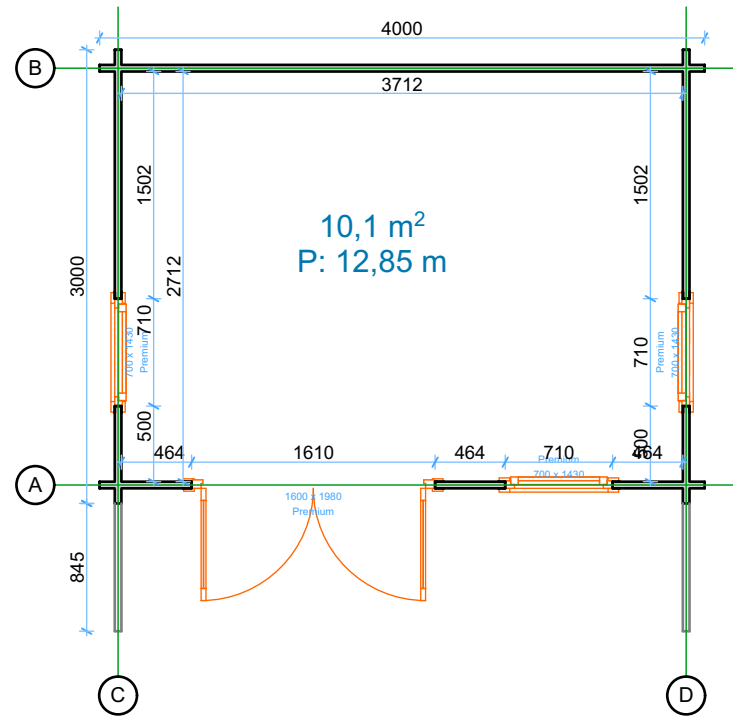

Thickness:	Project name:	Project ID:	Year:	Page:
44	Chertsey	4x3	2021	4

Wall A

1:50

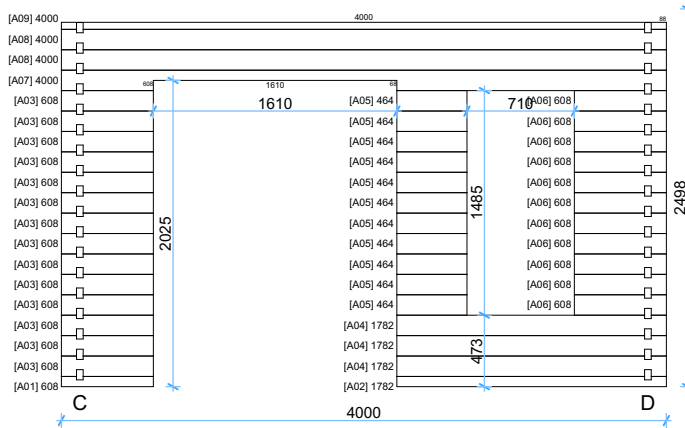

Wall B

1:50

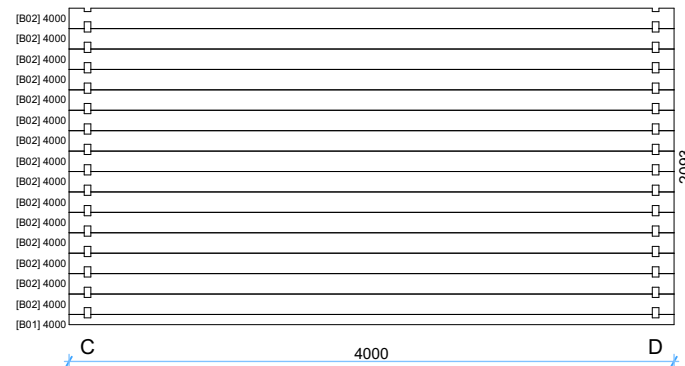

Wall C

1:50

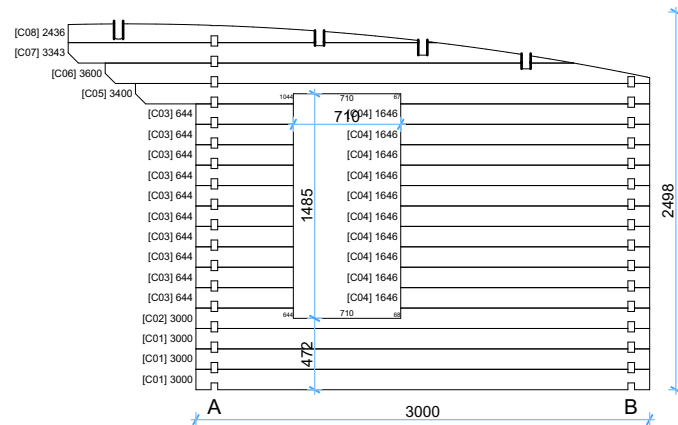

Wall D

1:50

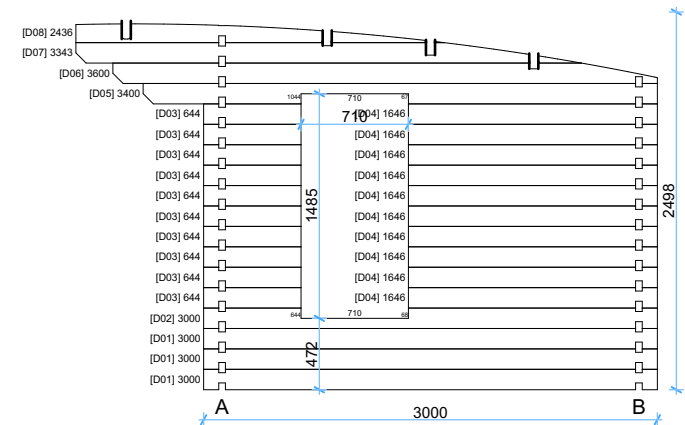

Thickness:	Project name:	Project ID:	Year:	Page:
44	Chertsey	4x3	2021	5

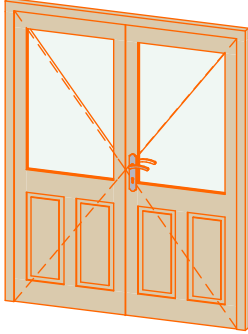
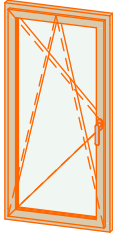
Windows and doors list					
Type-quality	W x H Size	Orientation	Glazing	Quantity	3D Axonometry
Door - Premium	1600×1980	R	50% glass, double glazed, safety "toughened" glass	1	
Window - Premium	700×1430	L	Double glazed, safety "toughened" glass	2	
Window - Premium	700×1430	R	Double glazed, safety "toughened" glass	1	